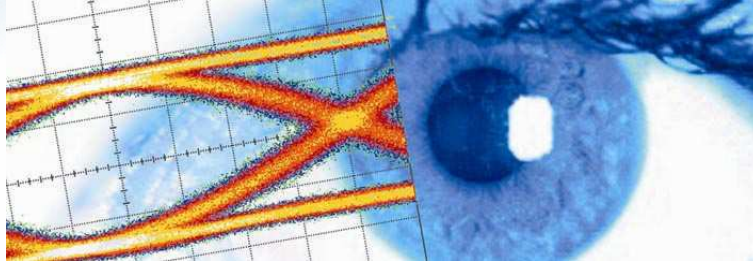




SHF Communication Technologies AG,
Wilhelm-von-Siemens-Str. 23 D • 12277 Berlin • Germany
Phone ++49 30 / 772 05 10 • Fax ++49 30 / 753 10 78
E-Mail: sales@shf.de • Web: <http://www.shf.de>



Application Note

Dual-Band Multi-Channel BPG SHF 12103/4 A





Content

Introduction	3
Truly Synchronized Multi-Channel Data Generation	4
Jitter Transparency	6
Applications	7
Optical (D)QPSK Signal Generation	7
Optical 16QAM Signal Generation	8
Optical DP-QPSK Signal Generation	12
High Baud Rate Optical (D)QPSK Signal Generation	15
100 Gbps Serial Data Generation	16
Pre(de)-Emphasis High Speed Back-Plane and PCB Design Applications	17
Setup Requirements for Two-Channel Pre-Emphasis at 28/32 Gbps	19
Cross-Talk Analysis	20



Introduction

Current market requirements point towards high channel count as a cost effective route to satisfying the ever increasing demand for capacity. Complex and highly spectral-efficient modulation formats invoking multi-level phase and amplitude, and coherent demodulation have become standard practices in the realization of long distance transmission.

As the technology for Si-based digital signal processing (DSP) matures and advances, and the burden of over-all system complexity begins to erode the benefits of increasing channel counts, future system evolution is expected to call on the increase in symbol rate as an effective element in the high capacity tool box. Therefore, the ability to deliver multi-channels at symbol rates beyond the current commercial product focus is highly desirable. This would enable early investigations on the high speed limits of many of the current complex modulation formats.

An important aspect of multiple signal propagation in a multi-channel system and component test bed, is the potential impact of cross-talk, which could manifest in either the amplitude/intensity and phase domains, or indeed both. Therefore, the ability to control and manipulate the bit sequence timing relationship between the propagating data streams becomes indispensable. In other words, the output data channels of the BPG must be bit synchronized and preferably adjustable over a wide range in fine resolution.

The objective of this note is to provide a reference to illustrate how to make the best use of the truly synchronous features, dual bit rate bands, and multi-channel nature of SHF 12103A and 12104A BPGs. Hardware implementation examples are given towards the realization of many advanced system experiments, as well as setups for module production tests in a manufacturing environment.



Truly Synchronized Multi-Channel Data Generation

The dual-rate broad band, multi-channel pattern generator SHF 12103/4A, features true synchronization between the output data streams, be it at the high rate band of 6 to 56 Gbps or 3- 32 Gbps.

- Upon pattern length selection, the internal pattern generators automatically set all the output data streams to the same starting bit at the beginning of the sequence. The time position is exactly aligned through internal clock synchronization.
- The timing relationship between the channels can be synchronized to within one bit via the bit delay control feature in the control software. The number of bit delay can be as long as the chosen sequence length. For example, if $2^{31}-1$ is chosen, the bit delay can range from 1 to 2,147,483,647.
- In the 3-32 Gbps band, a skew control option allows for phase adjustment, for each channel, in 0.1 ps resolution for precision delay control of up to ± 15 ps.

These features are particularly crucial for applications such as (D)QPSK, multi-level signal generation for QAM, multiple tap pre-emphasis via external components, cross-talk evaluation in multiple parallel channels measurements as Infini-Band, Fiber Channel and Data-Com testing. In these applications, the N bit delay per channel can be used to de-correlate the transmitted data streams, whilst the 0.1 ps resolution can be used to negate any channel path deviation in a complex multi-channel parallel test setup. Details of these specific applications are dealt with later in this note.

Figure 1 and 2 show, respectively, how the bit delay and timing skew control feature is setup in the BCC, and a timing diagram illustration of these features for one chosen data stream.

Channel Synchronisation

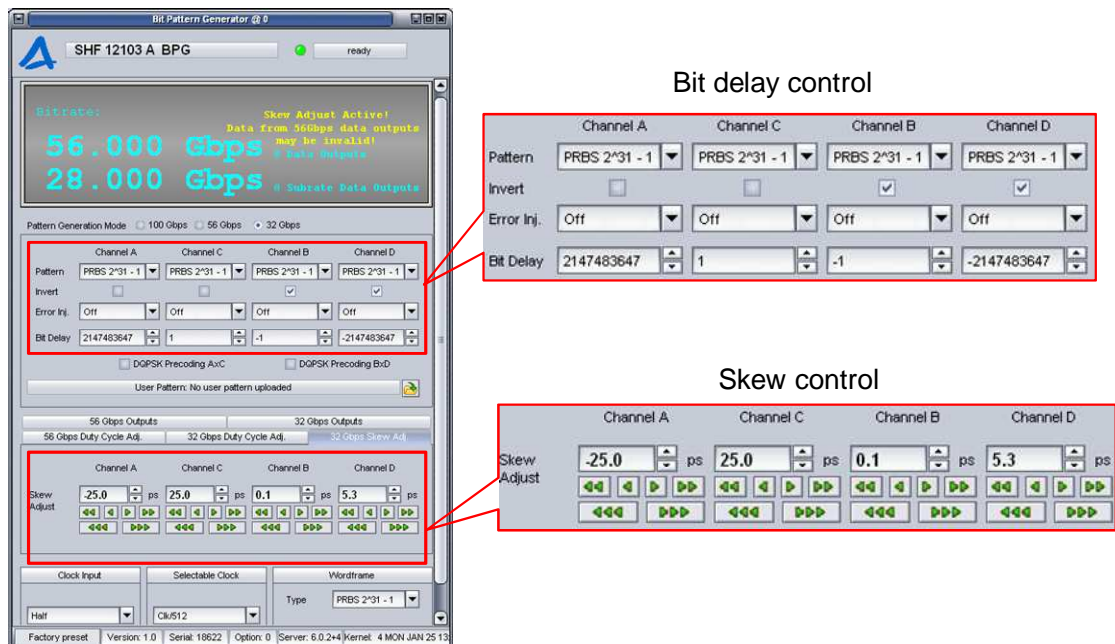
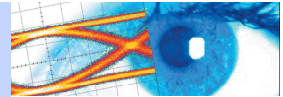
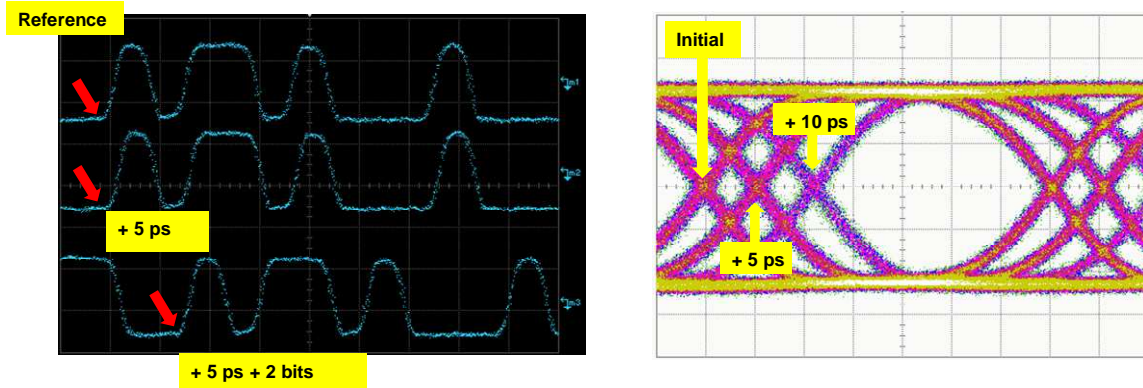
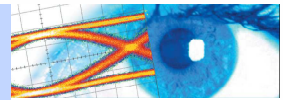


Figure 1



Bit Delay Control & Skew Control Feature



Each channel can be delayed in

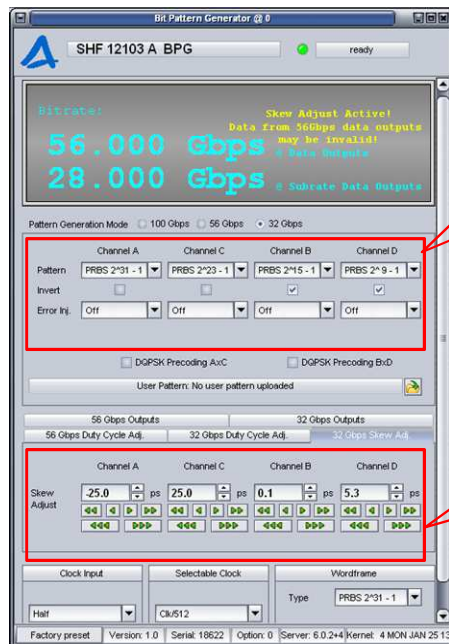
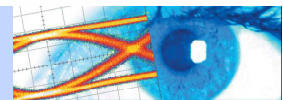
- Integer bits
- ± 25 ps at 0.1 ps resolution



Figure 2

However, once different pattern lengths are chosen, the bit delay function is automatically 'switched off', as the patterns are automatically de-correlated. This is illustrated in figure 3.

De-correlation via Pattern Length Mismatch



Bit delay function in-operative as all channels are automatically de-correlated



Skew control stays active



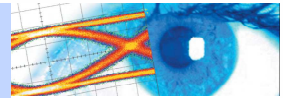
Figure 3



Jitter Transparency

Additionally, the 12103/4A family of BPGs is jitter-transparent, and this means the output data streams (both the 56 and 32 G outputs) can be jittered for stress tests commonly performed in transceiver module testing. Figure 4 below shows how a random jitter is 'copied' into the BPG data outputs. Using the SHF 78210A Option J1, and a suitable AWG, various modulation signals including sinusoidal, peak-to-peak as well as random jitter with an amplitude of up to 90 ps, and modulation frequency range of up to 1 GHz, can be 'copied' into the pattern generator. Further details on jitter transparency of the SHF 12103A, and the clock synthesizer with jitter injection are documented elsewhere¹.

Jitter Transparency



- Clock jitter generation using the SHF 78210A Option J 1
- Low frequency AWG to provide modulation source for different jitter types
- Jittered clock 'copied' to output data
- 90 ps jitter range, up to 1 GHz modulation
- 2.5 UI at 28 Gbps

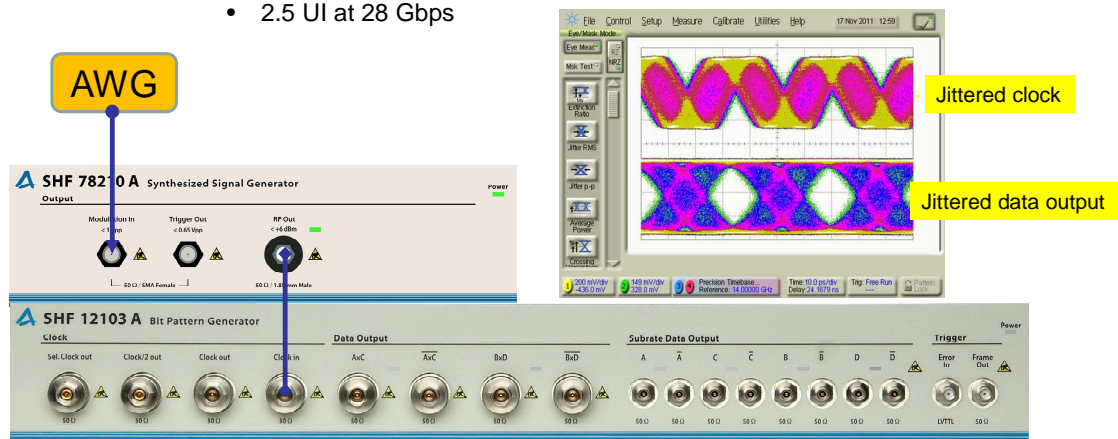


Figure 4

¹ Jitter Injection using the Multi- Channel BPG (http://www.shf.de/en/communication/support/application_notes/)



Applications

Optical (D)QPSK Signal Generation

- 2 data channels for I and Q modulation
- 2 cables of approximate lengths
- Skew control to mitigate input paths delay deviation
- Pre-coding for PRBS BER analysis after 1-bit delay demodulation at receive side
- Optical transmitter SHF 46213D
- DPSK receiver SHF 47215A or SHF 47215C may be used for 1-bit demodulation and error analysis using the SHF 11104A

Setup example using SHF 12103A Quad-28/32 option in figure 5 below:

64 Gbps (D)QPSK Signal Generation

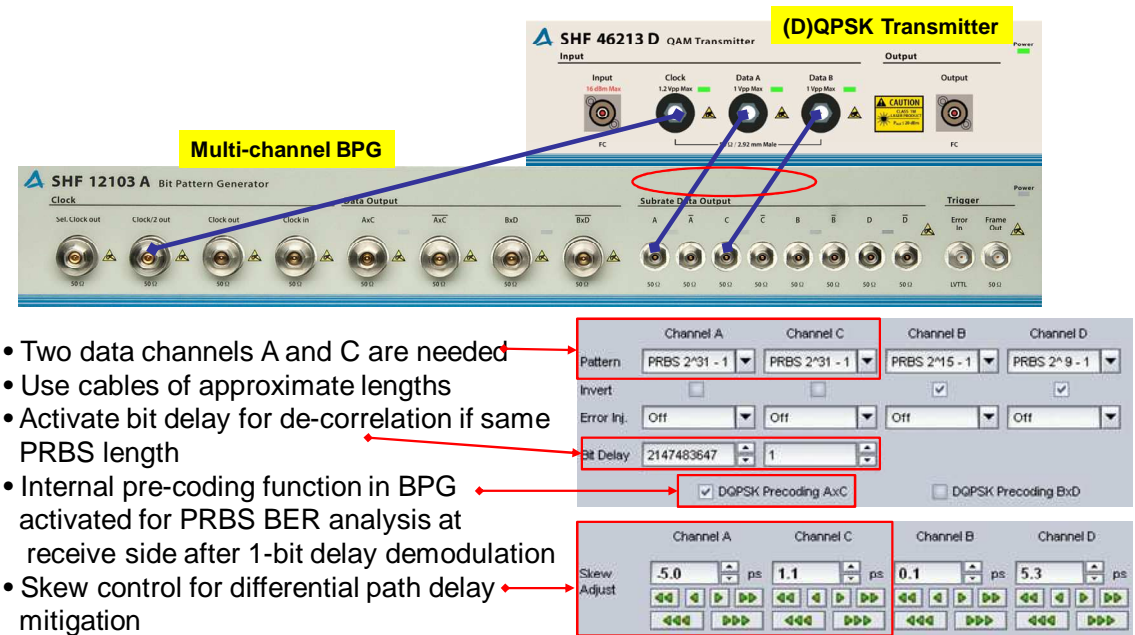


Figure 5

Figure 6a shows a typical directly detected two-level signal from the output of the transmitter, and which also shows that any differential path deviation between the two signal propagation paths has been minimized (through the BPG output skew control). The results obtained from using the Agilent N4391A modulation format analyzer is given in 6b which displays the re-construction from captured amplitude and phase data, the constellations as well as the eye pattern of the transmitted signal.

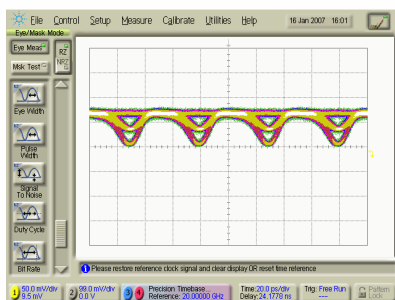


Figure 6a

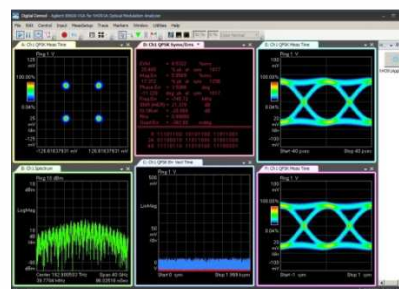


Figure 6b

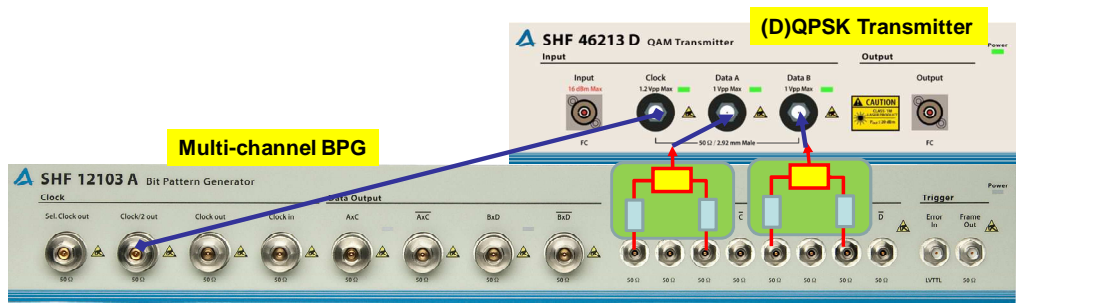


Optical 16QAM Signal Generation

Basic transmit side requirement

- 4 data channels, A, C, B & D
- Two 4-level signal generators are needed for I and Q modulation. These can be of the 'all-passive' type as described in the 'Multi-level' signal generation' application note², or a DAC
- A, C to form one 4-level signal, and B, D form a 2nd 4-level signal for I-Q modulation as shown in figure 7
- Skew control for optimum 4-level signal generation, as well as to mitigate input paths delay deviation
- Use A, C, B & D amplitude control for eye-opening pre(de)-emphasis for optimum constellation generation. Figure 8 illustrates how this is realized using the amplitude and skew control on the BCC software
- For coherent transmission experiments or coherent receiver assessment, de-activate pre-coding function
- Optical transmitter SHF 46213D
- Constellation analysis using a variety of commercial tools such the Agilent N4391A, and EXFO PSO 200 had been successfully trialed

16QAM Signal Generation



Multi-channel BPG (SHF 12103 A) and **(D)QPSK Transmitter** (SHF 46213 D) are shown. The BPG is configured for four channels (A, B, C, D) with PRBS patterns and skew adjustments.

- Four data channels A and C are needed
- Two 4-level signal generator are needed
- Use cables of approximate lengths
- Activate bit delay for de-correlation if same PRBS length
- De-active pre-coding function in BPG for coherent-related analysis
- Skew control for differential path delay mitigation

Channel	Pattern	Invert	Error Inj.	Bit Delay	DQPSK Precoding	Skew Adjust (ps)
Channel A	PRBS 2 ^{*31} - 1	<input type="checkbox"/>	Off	2100000000	<input type="checkbox"/>	-5.0
Channel C	PRBS 2 ^{*31} - 1	<input type="checkbox"/>	Off	1	<input type="checkbox"/>	1.1
Channel B	PRBS 2 ^{*23} - 1	<input type="checkbox"/>	Off		<input type="checkbox"/>	0.1
Channel D	PRBS 2 ^{*15} - 1	<input type="checkbox"/>	Off		<input type="checkbox"/>	5.3



Figure 7

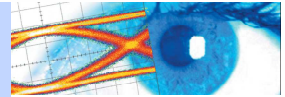
It is worth noting that in addition to the 'all-passive' method, a multi-level signal can also be generated using a high speed DAC with an appropriate number of effective bits. The following sections will describe how to implement the 'all-passive' 4-level generator, and the use of a 3-bit DAC for 4- and 8-level signal generation.

² 'Multi-level' generation using the multi-channel SHF 12103A' (http://www.shf.de/en/communication/support/application_notes/)





4-level Signal Generation-Passive Approach



BCC Software control of the 4-Level parameters

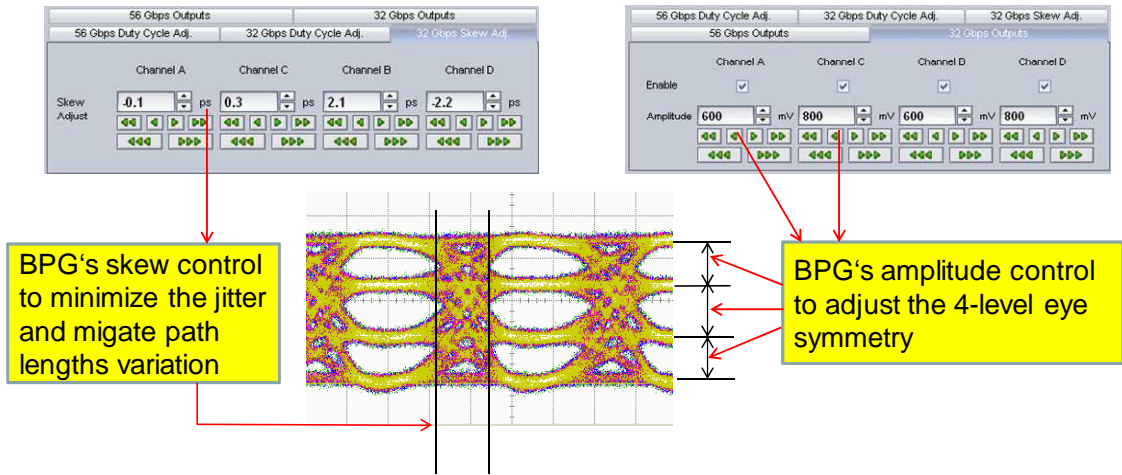


Figure 8

Figure 9 shows a 4-level signal generated by optimizing the amplitude and skew control of the BPG, and the coherently detected signal at the output of the QAM transmitter.

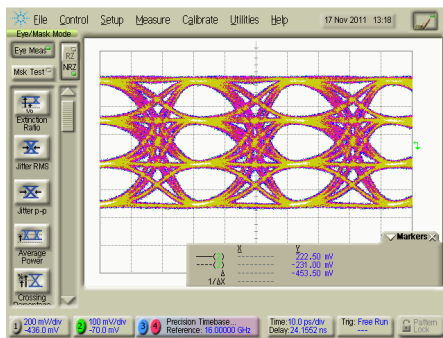


Figure 9a

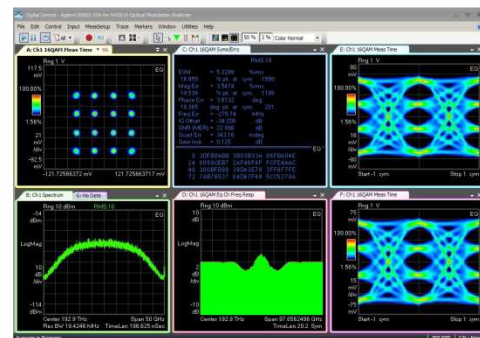


Figure 9b

It is worth pointing out that the 'all-passive' 4-level generator, or the custom-designed semi-rigid cables can be obtained from SHF. A picture of this all-passive structure is shown below.

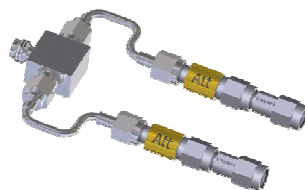


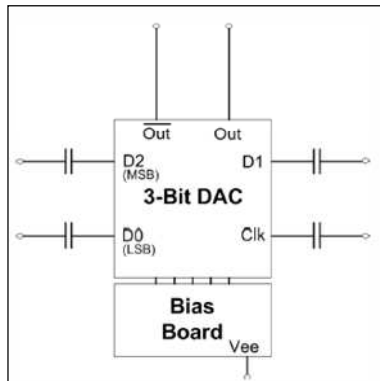
Figure 10 'All-passive' 4-level signal generator



Figure 11 shows the salient features of a high speed 3-bit DAC appropriately designed for the generation of high baud rate 4- and 8-level signals. Potential applications includes high baud rate QAM for future systems beyond 100G, as well as the next generation 100GbE for client-side and short reach applications such as PAM-4 and PAM-8. Key features of this module, SHF 611A, is the on-chip signal regeneration at the inputs and re-configurability for either 2- or 3-bits. The former renders the multi-level signal generation process less sensitive to cable/component related bandwidth and length issues between the BPG and the multi-level signal generator. This means, the multi-level generator can be brought closer to the optical transmitter, rather like a 'remote head'. Although an additional clock input is necessary for the input signal regeneration function.

3-Bit DAC for Multi-level Signal Generation

- Configurable to 2- or 3-bit binary inputs
- DFF for retiming and re-shaping of input data streams
- Target baud rate 32 GBaud
- Input data amplitude 100 mV min, 250 mV max
- Clock input amplitude 100 mV min, 200 mV max
- Adjustable output amplitude
- External bias board included



Maximum Output Amplitude			
Input D2	Input D1	Input D0	Output Amplitude (typ. ±10%) [mV]
-	-	On	150
-	On	-	270
-	On	On	390
On	-	-	540
On	-	On	680
On	On	-	800
On	On	On	930

4-level (rows 3, 4, 5, 6)
8-level (rows 7, 8)



Figure 11

Typical multi-level signal waveforms resulted from using this approach are illustrated in figures 12, configured for 2-bits, and 13 for 3-bits operation. When configured for 2-bits, operation up to at least 43 GBaud is possible, whilst 32 GBaud appears to be the limit for 8-levels, for the technology used.



4-Level for 16QAM & PAM-4

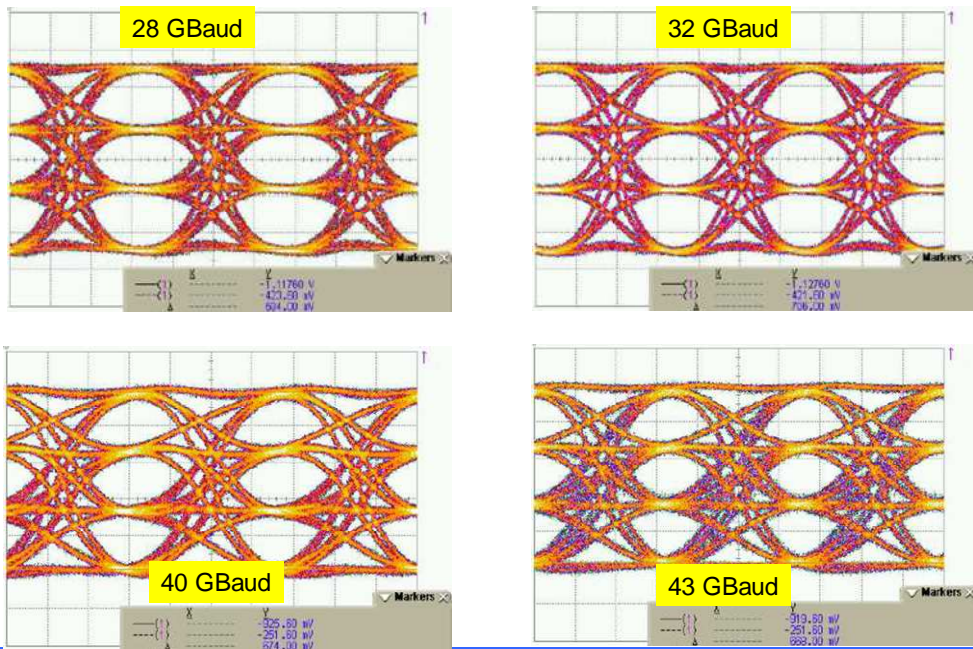
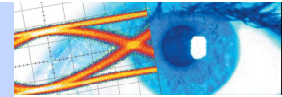


Figure 12

8-Level for PAM-8

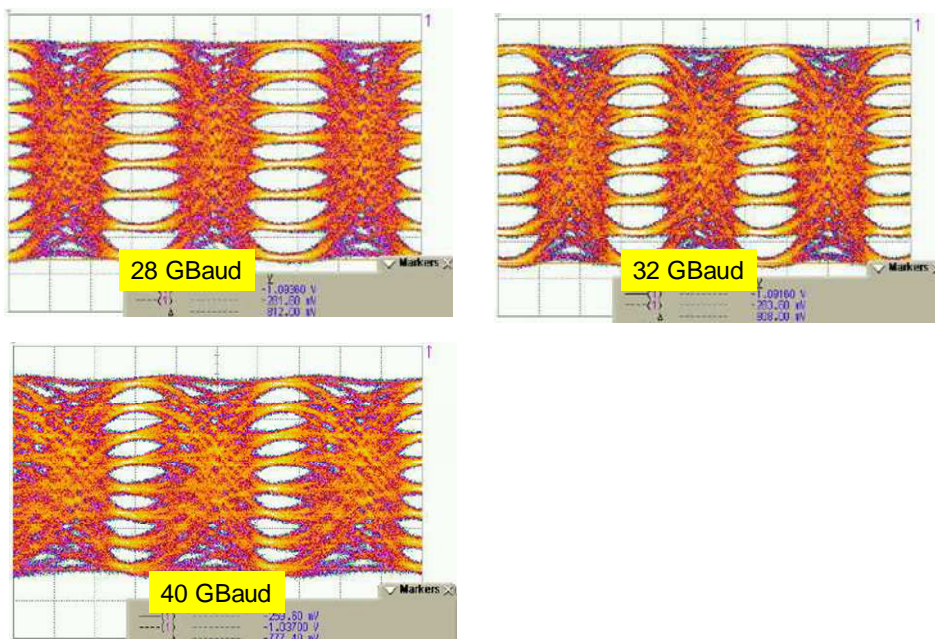
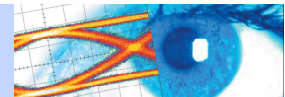


Figure 13



Optical DP-QPSK Signal Generation

Basic transmit side requirements

- 4 data channels, A, C, B & D
- A, C for X-Pol I-Q modulation and B, D for Y-Pol I-Q modulation
- 4 cables of approximate lengths
- Skew control to mitigate input paths delay deviation
- For coherent transmission experiments or coherent receiver assessment, de-activate pre-coding function
- For direct detection analysis, pre-coding may be activated for PRBS BER analysis after 1-bit delay demodulation at receive side
- Optical transmitter SHF 46215A
- Constellation analysis using a variety of commercial tools such the Agilent N4391A, Tektronix OM4106D and EXFO PSO 200 had been successfully trialed

Setup example using SHF 12103A Quad-28/32 option is shown in figure 14, whilst the dual polarization signal as captured and displayed by a coherent signal analyzer, EXFO PSO-200 is illustrated in figure 15.

128 Gbps DP-QPSK Signal Generation

DP-QPSK Transmitter

Multi-channel BPG

- Four data channels A, B, C and D needed
- Use cables of approximate lengths
- Activate bit delay for de-correlation if same PRBS length
- De-activate pre-coding function in BPG for coherent-related analysis
- Skew control for differential path delay mitigation

Channel A	Channel C	Channel B	Channel D
Pattern: PRBS 2 ³¹ -1	Pattern: PRBS 2 ³¹ -1	Pattern: PRBS 2 ²³ -1	Pattern: PRBS 2 ¹⁵ -1
Invert: Off	Invert: Off	Invert: Off	Invert: Off
Error Inj: Off	Error Inj: Off	Error Inj: Off	Error Inj: Off
Bit Delay: 2100000000		1	
<input type="checkbox"/> DQPSK Precoding AxC		<input type="checkbox"/> DQPSK Precoding BxD	
Skew Adjust: -5.0 ps	Skew Adjust: 1.1 ps	Skew Adjust: 0.1 ps	Skew Adjust: 5.3 ps

Figure 14

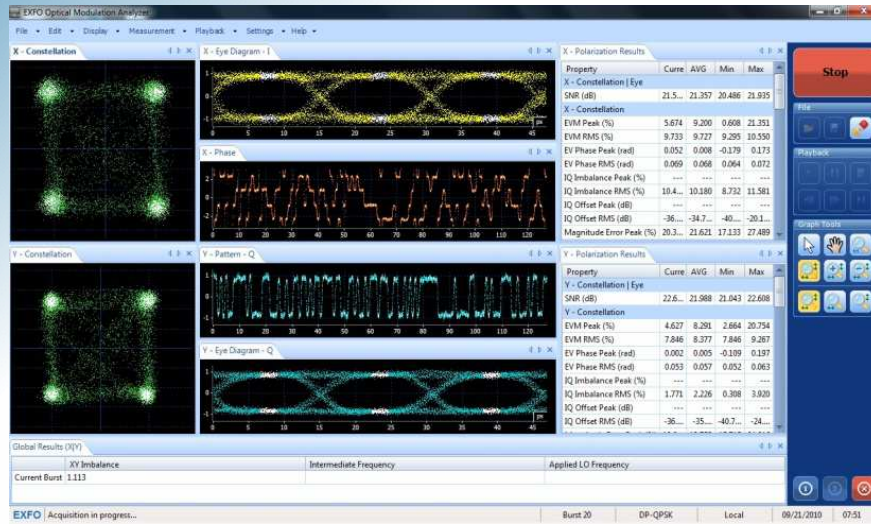


Figure 15
Dual-polarization signal captured by the PSO-200 constellation analyzer



DP-16QAM Signal Generation

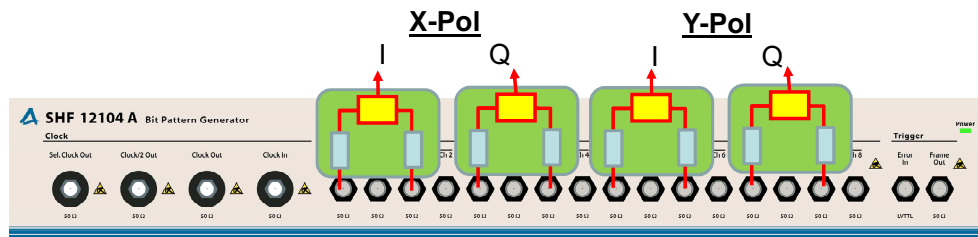
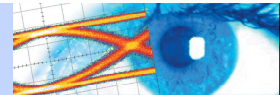
In this application, the SHF 12104A Oct-28/32 would be the ideal candidate for the binary data streams. All the other key functionalities such as skew and amplitude controls remain the same as the SHF 12103A.

Basic transmit side requirements

- SHF 12104A for 8 data channels
- Four 4-level signal generators are needed for the X- and Y-polarisations and I and Q modulation for each polarisation
- These 4-level generators can be of the 'all-passive' type as described in the 'Multi-level' signal generation' application note (Note 2), or the 3-bit DAC as described earlier
- 8 cables of approximate lengths
- Skew control to mitigate input paths delay deviation
- Use binary data amplitude control for eye-opening pre(de)-emphasis for optimum constellation generation.
- The SHF 46215 may be considered as the optical transmitter for generating the dual-polarization 16QAM optical signal.

Figure 16 below suggest how the new generation of multi-channel BPG, the SHF 12104A with eight output channels may be used as the data source to form the four 4-level signals for I-Q modulation.

4-level signal generation for DP-16QAM



4-level signal generation can be the 'all-passive' approach or an active DAC



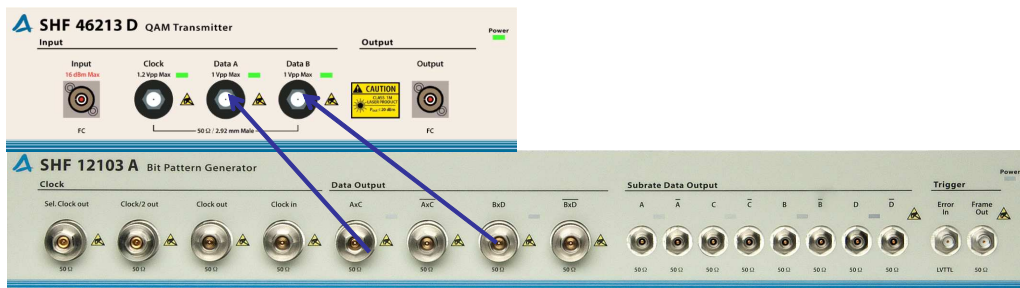
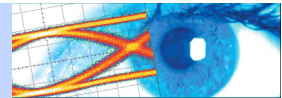
High Baud Rate Optical (D)QPSK Signal Generation

In this application, two high speed outputs of the BPG are used. Currently, the internal skew timing control feature is not installed, and therefore either a suitable external delay line is used, or a pair of custom-matched cables is to be used to mitigate any timing variation in the propagation paths between the BPG and the modulator structure.

- Dual-56 data channels for I and Q modulation
- 2 custom-matched cables
- Pre-coding for PRBS BER analysis after 1-bit delay demodulation at receive side
- Optical transmitter SHF 46213D
- DPSK receiver SHF 47215A or SHF 47215C may be used for 1-bit demodulation and error analysis using the SHF 11104A

Setup example using SHF 12103A Dual-56 and SHF 46213D is shown in figure 17.

Dual-56G for 112G (D)QPSK transmission

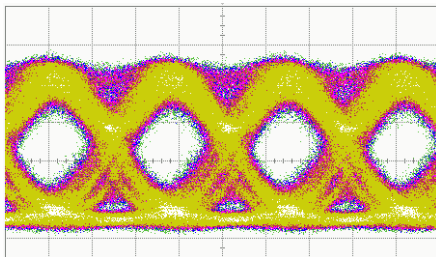


- Use custom-matched cables or suitable external delay line for I-Q bit alignment
- Software pre-coding via 1Gb user pattern memory for BER analysis in PRBS mode
- In NRZ mode, operation up to 56 GBaud (112 Gbps capacity) guaranteed, 64 GBaud has been shown to be possible

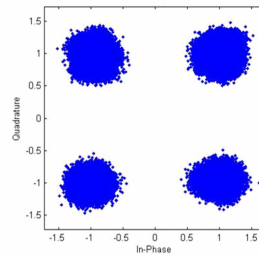


Figure 17

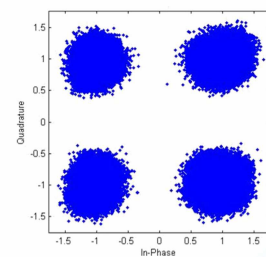
Figure 18 shows the demodulated I(Q) channel using a variable rate 1-bit delay demodulator, and the constellation as captured by a coherent receiver front-end.



55 Gbaud
S/N: 5.9, Jitter: 1.8 ps



56 Gbaud



64 Gbaud

Constellation diagrams extracted from coherent receiver and off-line DSP "Courtesy of Prof. David V. Plant, ECE Dept., McGill University"



100 Gbps Serial Data Generation

Both the SHF 12103A and 12104A with Dual-56 option can be used for this application. A dedicated setup selection is built-in to ensure the two 56G outputs are maintained at 1/2 pattern length delayed at all times and all PRBS pattern lengths. Since there is no internal skew control in the current product offering, the user is recommended to use two custom-matched cables. If external delay lines are used, care must be taken to mitigate any path delay difference.

Setup example using SHF 12103A Dual-56 is shown in figure 19. For detail setting up of the 100 G 2:1 multiplexer, the reader is referred to the corresponding application note³.

Dual-56G for Serial 100G Data Generation

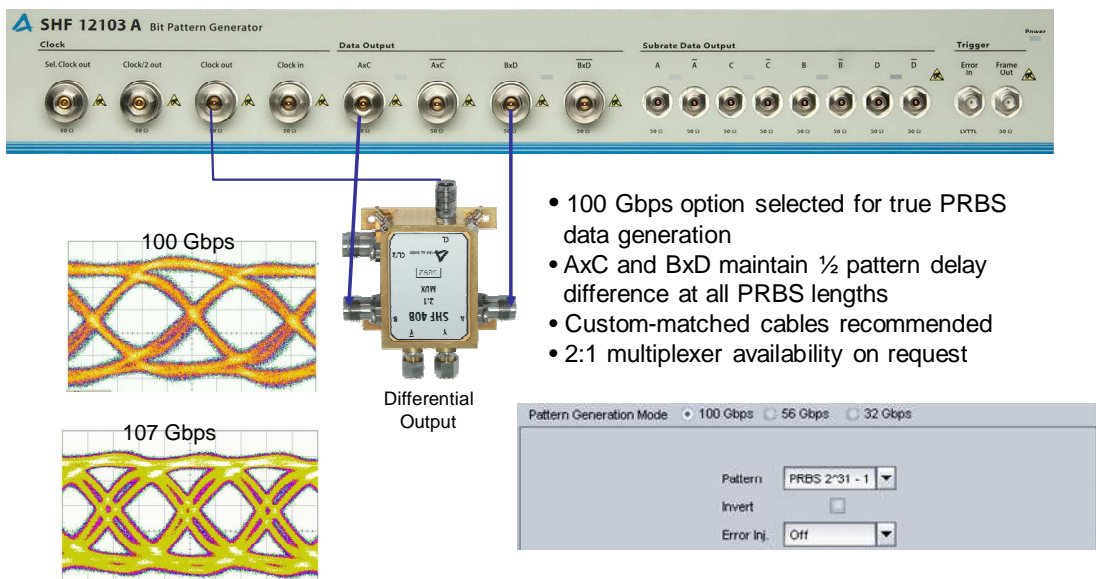
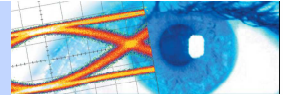


Figure 19

³ Application note AN 408 on request.



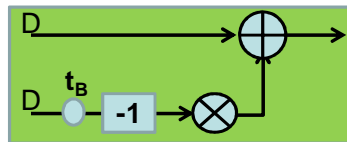
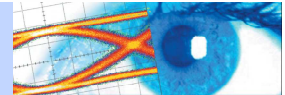
Pre(de)-Emphasis High Speed Back-Plane and PCB Design Applications

As a result of the multi-channel nature of the SHF 12103/4A, the BPG lends itself readily configurable for pre(de)-emphasis investigations. However, currently this functionality can only be implemented using external components, chiefly attenuators and power combiners. The number of taps in the pre-emphasis function that can be implemented will depend on the number of binary data channels available, and to a large extent, the complexity that can be conveniently managed.

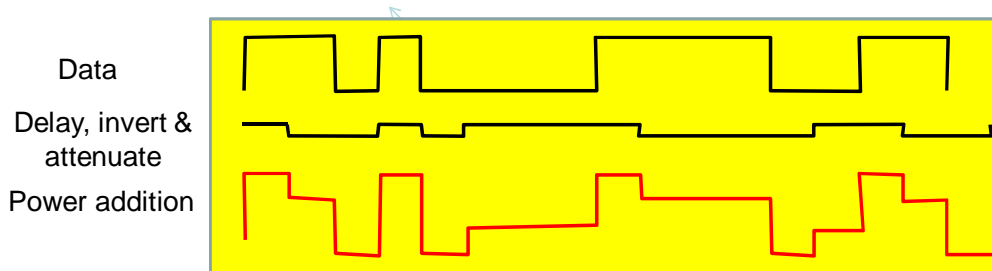
For most applications in the evaluation of propagation loss in high speed back plane connections, and high speed line designs in PCBs, a one-tap implementation should incorporate, for most practical purposes, all the important effect commonly encountered.

Figure 20 shows the basic principle involved for the case of the simple one-tap pre-emphasis.

Basic Pre-emphasis (One Tap)



One-tap pre-emphasis logical representation

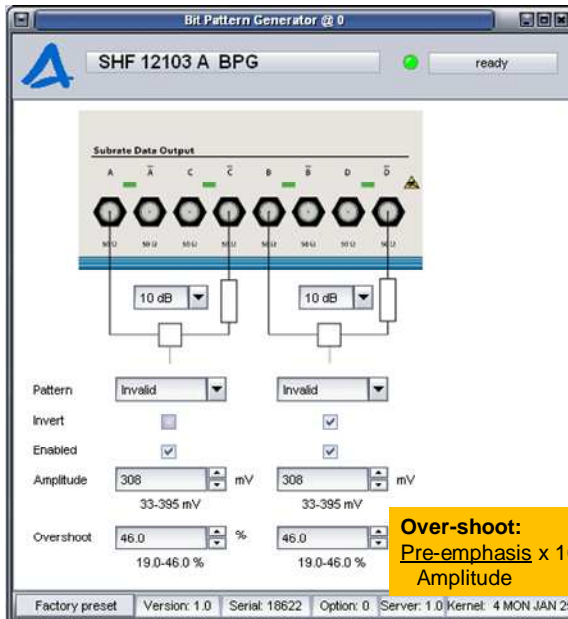
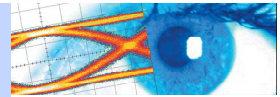


One-tap pre-emphasis timing diagram



The BCC control software representation for an example of one-tap pre-emphasis configured for two-channel, and the key parameter definitions are shown in figure 21.

Software Control



- External attenuators and combiners assumed
- Internal channel skew control invoked
- Attenuator value sets the output signal amplitude and over-shoot range
- Higher the value, lower is the amount of over-shoot

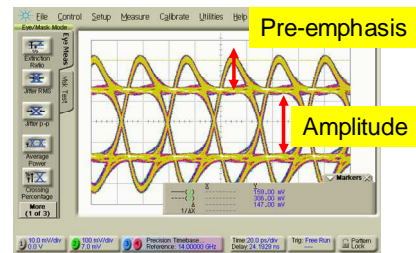


Figure 21

Figure 22 shows the an example on how the dispersion of a 3.5 m long SMA cable can be compensated with 40 % of overshoot in the pre-emphasized signal at the bit rate of 32 Gbps.

With & Without Pre-emphasis

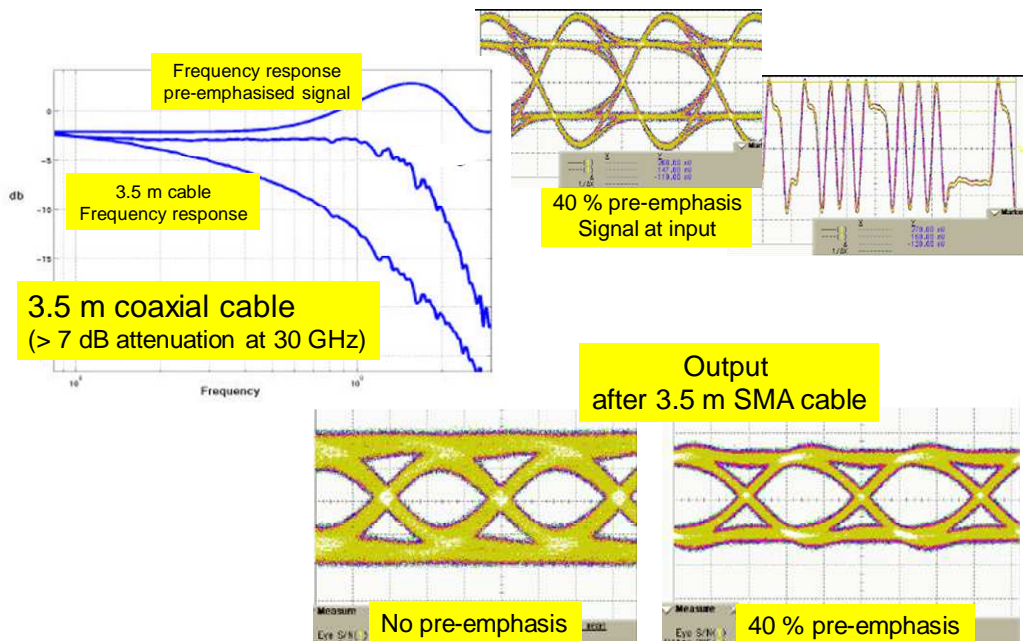
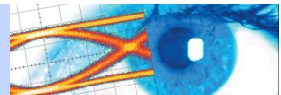


Figure 22

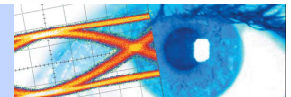


Setup Requirements for Two-Channel Pre-Emphasis at 28/32 Gbps

- Two external combiners
- Attenuators as required for the magnitude of pre-emphasis
- SHF 12103A Quad-28/32 with skew control option

Figure 23 shows the practical implementation using the SHF 12103A and external attenuators and power combiners to form two pre-emphasized channels. The bit delay feature provides the one bit delay required for the one-tap implementation, whilst the skew control allows for sub-ps fine tuning for any remaining path delay variation. The choice of attenuator value will determine the amount of pre-emphasis and signal amplitude realizable. These signal parameters are selected through the BCC software as shown in figure 18.

Pre-emphasis With the Multi-channel SHF 12103A



- Two independent data channels for one pre-emphasized output stream
- Internal bit delay control, data inversion & amplitude adjust for pre-emphasis
- Addition external components readily available
- Two additional pre-emphasized outputs can be formed with remaining output ports

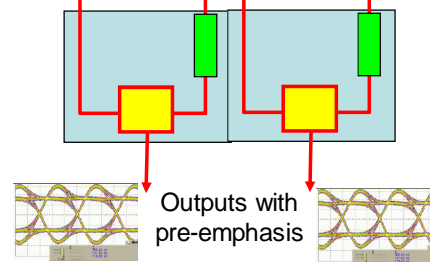


Figure 23

In the event that more four pre-emphasized channels are needed, it is possible to make use of the un-used data and inverted data outputs, too. In this case the two extra channels are the inverted version of the previous.

Should even more channels are required, it would be worth considering using the SHF 12104A Oct-32 with eight data streams, providing 16 single ended outputs.



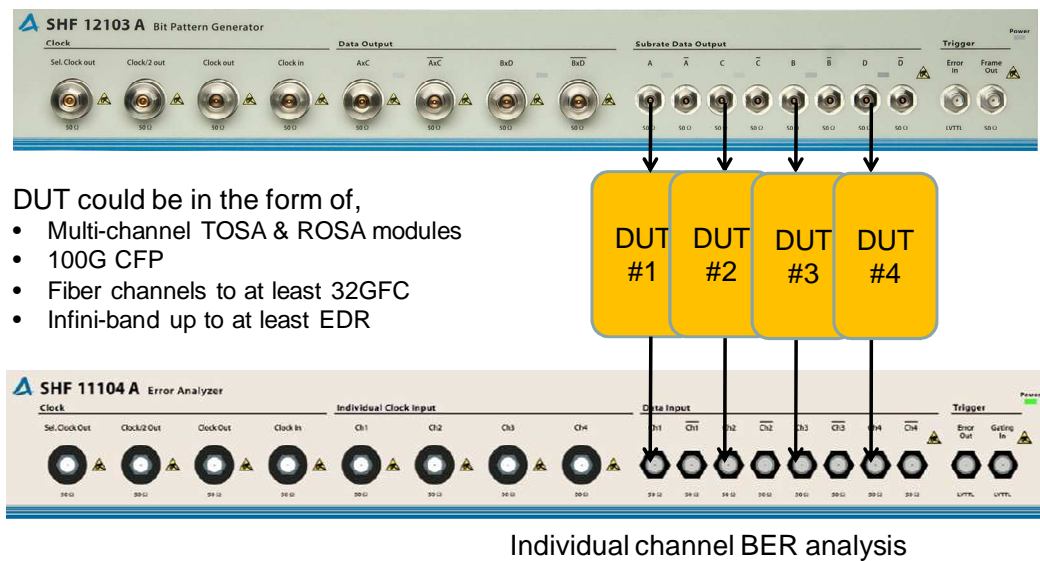
Cross-Talk Analysis

In general, crosstalk occurs when a signal is affected by the transmission of another signal on its adjacent transmission lanes, through coupling of electromagnetic radiation. The latter is commonly in the form of RF as well as optical signal formats.

For this kind of investigation, two or more data channels are needed, one channel interferes, whilst the other(s) suffers from such disturbance. However, in some cases, it may be necessary to study the impact of more than one source of disturbance. This is especially true in practical scenarios where many channels on a single back plane interconnect or a multi-channel/multi-layer PCB, and in the case of an optical system, when a large number of WDM channels, at different wavelengths, even different bit rate and modulation formats are transmitted in a single fibre. In these situations, the ability to set the individual test data pattern length, relative timing relationship between data streams are mandatory to explore the degree of correlation and its impact on the damage due to crosstalk. A possible experimental setup for crosstalk investigation is shown in figure 24, involving the SHF 12103A Quad-28/32, 4-channel BPG, as the data source and the SHF 11104A Quad-28/32, 4-channel error analyser.

CFP, Fiber Channel, Infini-band Testing

Example of 4-channel test setup, 3-32 Gbps coverage



- DUT could be in the form of,
- Multi-channel TOSA & ROSA modules
 - 100G CFP
 - Fiber channels to at least 32GFC
 - Infini-band up to at least EDR

Individual channel BER analysis



Figure 24

Should more than 4 channels needed, the SHF 12104A Oct28/32 and the SHF 11104A Oct-28/32 with eight channels capability may be considered. The former provides all the pre-requisite synchronization features required, whilst the latter can be configured either with a single common clock input or individual clock inputs rendering the individual channels completely independent to one another.