



SHF Communication Technologies AG

Wilhelm-von-Siemens-Str. 23 • Aufgang D • 12277 Berlin – Marienfelde • Germany

Phone ++49 30 / 772 05 10 • Fax ++49 30 / 753 10 78

E-Mail: sales@shf.biz • Web: <http://www.shf.biz>

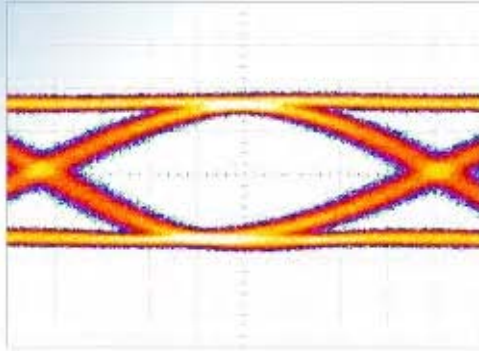

Preliminary Datasheet

SHF 5008 DPSK

Optical Receiver





Description

Differential phase-shift keying (DPSK) is a well-known coding method which is of current interest in the transmission of high bit rate signals through optical fibers. Compared to the more conventional amplitude-shift keying (ASK), DPSK offers higher sensitivity and enhanced robustness against the impact of non-linear effects in DWDM transmission.

The SHF 5008 DPSK offers a solution for the demodulation of DPSK-encoded optical signals and conversion back into signals for analysis. It is intended for use in conjunction with the SHF 5003 DPSK optical transmitter.

Features

- Decodes NRZ, RZ and CS-RZ DPSK signals
- High sensitivity
- GPIB connector for remote control
- All features computer controlled
- User-specified bit rate (broadband operation is not possible)

SHF 5008 DPSK Receiver functional block diagram

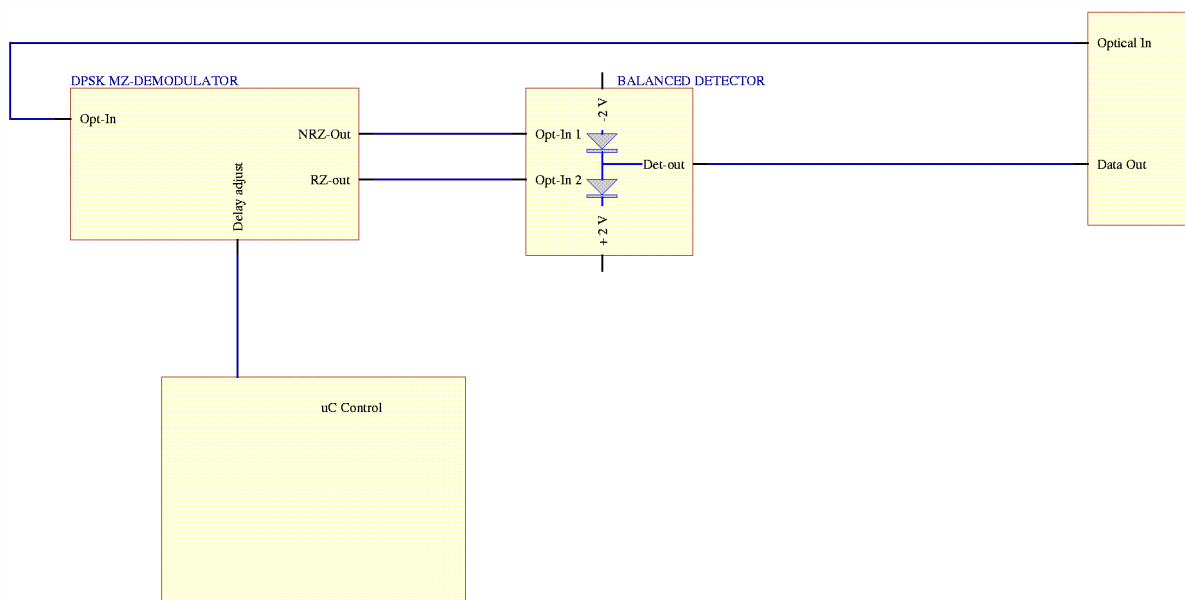



Specifications – SHF 5008 DPSK

Parameter	Unit	Min.	Typ.	Max.	Conditions
Decoder					
Operating wavelength	nm	1520		1620	
Optical input power into receiver	dBm			10	mean power
Optical return loss	dB		25		
Optical isolation	dB		25		
Excess optical loss	dB		0.35		
Data rate	Gb/s	39.8		43	One fixed data rate per decoder. User to specify.
Decoder phase tuning range	FSR			2	
Decoder phase tuning coefficient	mA ² /GHz		14		fiber heater operation only
Phase tuning response	second		0.4		fiber heater operation only
Balanced detector					
Electro-optic bandwidth	GHz		45		broad band operation
Detector responsivity		0.5	0.6		at DC
Detector responsivity matching	%		10		
Common-mode rejection	dB	12 12			Up to 20 GHz 20 to 50 GHz
PDL			0.4	0.8	
Output signal					
Electrical output return loss	dB			-10	
Positive and negative pulse amplitude matching	%			20	worst case
Positive and negative pulse delay matching	ps			3	
Output pulse amplitude	mV		200		+10 dBm mean optical input power
Output pulse width (FWHM)	ps				
RZ			10		
CS-RZ			15		
Output pulse zero crossing	mV		0		
Receiver sensitivity	dBm	-34			SHF 5003 DPSK as transmitter. See reference measurement set up



Absolute maximum ratings

Parameter	Unit	Min.	Typ.	Max.	Conditions
Optical input power into receiver	dBm			13	CW
Maximum fiber heater current for MZI decoder	mA			30	

General specifications

Parameter	Unit	Min.	Typ.	Max.	Note
Weight	kg		9		
Dimensions	mm				472x365x110
Power supply	V	90 180	110 230	135 270	47...63 Hz
Power consumption	W		TBA		
Operating temperature	°C	10		35	
Electrical data output connector			V (1.85mm)		
Optical connectors			FC/PC		

Test Measurements

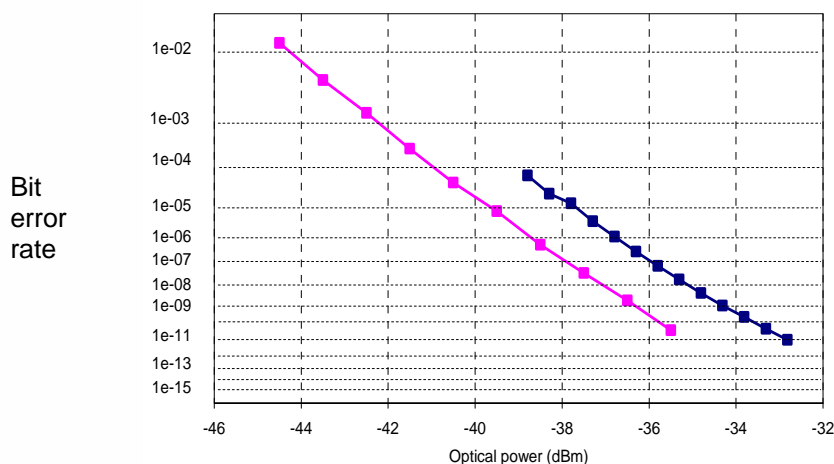
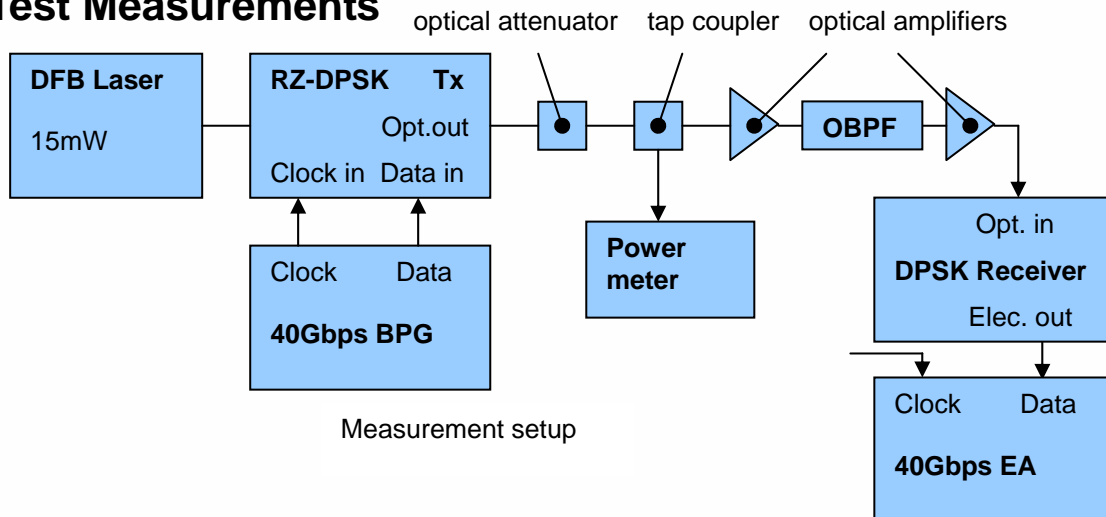

Two measurements made under different conditions. Magenta (left): 40 Gbps with a 70 GHz optical bandpass filter and a preamp with 4dB noise figure. ~45 photons/bit Blue (right): 42.4 Gbps with a 1.2nm optical bandpass filter and a preamp with 5.5dB noise figure. ~71 photons/bit. Sensitivity limit: 20 photons/bit

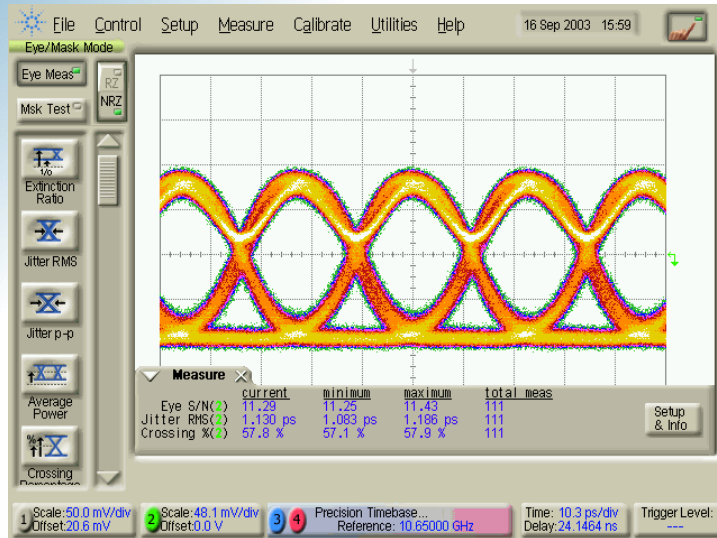

42.6 Gbps NRZ optical output signal. S/N: 11.3; RMS Jitter: 1.13 ps

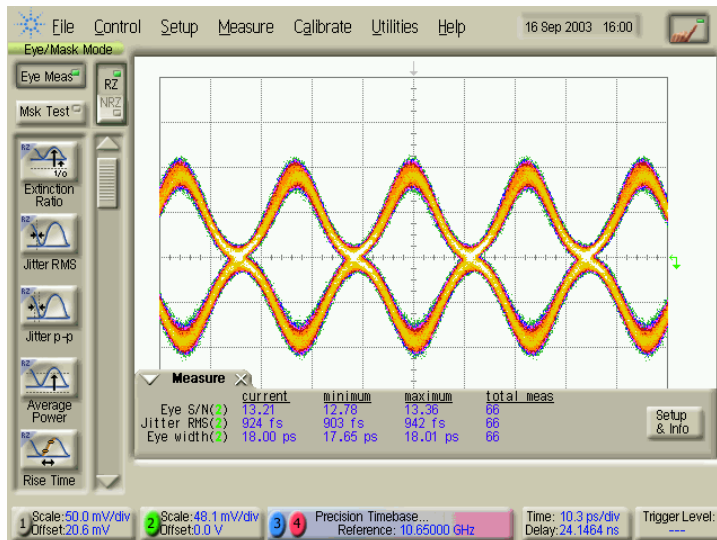

42.6 Gbps RZ optical output signal. S/N: 13.2; RMS Jitter: 924 fs

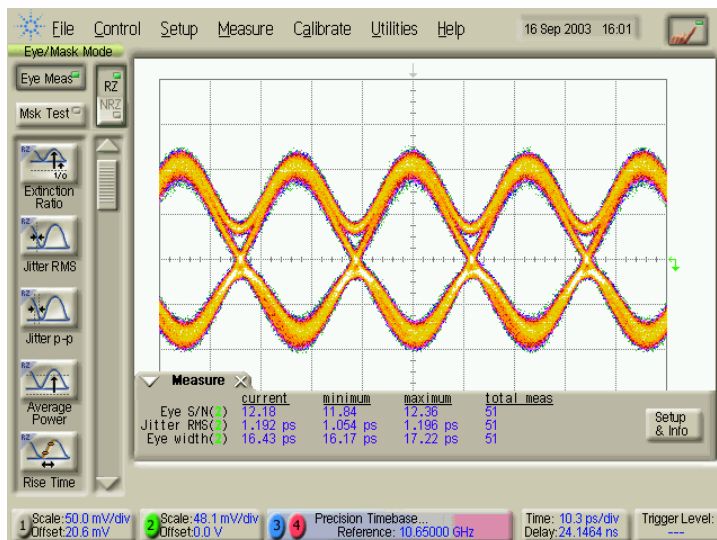

42.6 Gbps CS-RZ optical output signal. S/N: 12.2; RMS Jitter: 1.19 ps