



SHF Communication Technologies AG,

Wilhelm-von-Siemens-Str. 23 D • 12277 Berlin–Marienfelde • Germany

Phone ++49 30 / 772 05 10 • Fax ++49 30 / 753 10 78

E-Mail: mail@shf.de • Web: <http://www.shf.de>

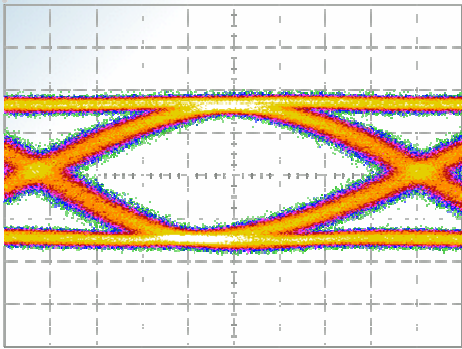

Datasheet

SHF 46210B

Multi-format Optical Transmitter



Description

The SHF 46210 B is an optical transmitter unit. This is a half-width plug-in for the SHF 10000 A mainframe. Field installation or upgrade by the end-user is possible for this equipment.

The SHF 46210 B Optical Transmitter converts electrical signals into optical signals at a data rate of up to 50 Gbps. It is able to encode the data in ASK (amplitude shift keying) and DPSK (differential phase shift keying) formats. With NRZ, Conventional RZ and Carrier Suppressed RZ, a total of six formats are supported. When used in DPSK mode, the SHF 47210 DPSK Optical Receiver is an ideal instrument for decoding the signal.

ASK is the more familiar method used in optical communications. The light intensity is varied so that light on corresponds to "1" and light off corresponds to "0", or vice versa. DPSK is a well-known coding method which has recently received interest in the transmission of high bit rate signals through optical fibers. Data is encoded by changing the phase of the light. Compared to the more conventional ASK, DPSK offers higher sensitivity and enhanced robustness against the impact of non-linear effects in DWDM transmission.

The main elements of the SHF 46210 B are two thermally stable Chirp-free Lithium Niobate Mach-Zehnder modulators which are each driven by an individually optimized amplifier. For the RZ modes, an amplifier amplifies a clock signal which is used to drive the first modulator. The output from this modulator is a train of pulses of constant width. These pulses are fed into the second modulator. The pulsed light is then modulated by the data signal. In this way, RZ signals are produced from an incoming NRZ signal. For the NRZ modes, the first modulator is biased to allow light through continuously.

The temperature stable modulators and an automatic bias circuit ensure high stability of the output signal.

Features

- 50 Gbps optical data streams
- < 9 ps rise and fall time digital optical signals at 44 Gbps
- 50 kHz to >40 GHz E/O conversion bandwidth (typical)
- Quick optimization of optical eye diagram performance by user adjustable gain and modulator bias control
- All features computer controlled
- Both modulators' bias conditions controlled automatically
- Selectable automatic and manual bias control (ABC circuit)
- SONET/SDH compatible

Functional block diagram

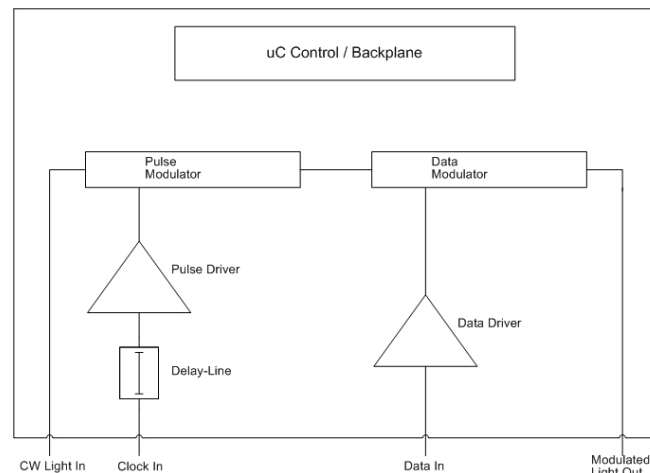



Specifications – SHF 46210 B

Parameter	Unit	Min.	Typ.	Max.	Comment
Optical parameters					
Wavelength range		C- and L-band			
Insertion loss	dB		11	13	connector to connector, maximum transmission without modulation
DC Extinction ratio	dB		20		
Return loss	dB		30		without optical connector
Chirp (Alpha parameter)					small signal measurement method ¹
Positive slope				0.2	
Negative slope				-0.2	
Electrical and electro-optical parameters					
Electro-optical bandwidth of Data modulator	GHz	25			-3dB electrical
Bit rate	Gbps				
RZ		36		44	
Data		6		50	
Drive amplifier electrical return loss	dB				
Data				-10	
Clock pulse RZ				-10	
ASK-Mode operation (Datarate 36 ... 44 Gbps)					
Drive amplifier input level	Vpp				
Data input	(dBm)	0.22 (-9)	0.28 (-7)	0.4 (-4)	
RZ clock input		0.5 (-2)	0.6 (0)	1.2 (6)	
Dynamic extinction ratio	dB				measured between data '1' and long sequence of '0'
NRZ		11	13		
RZ		12	14		
CS-RZ		12	14		
Dynamic signal to noise ratio					
NRZ			15		
RZ			18		
CS-RZ			16		
Output rise and fall times	ps				20%...80% as displayed on oscilloscope
NRZ			9	10	
Pulse width (FWHM)	ps				measured with 70 GHz detector and 70 GHz sampling scope
RZ			12		
CS-RZ			15		
Output timing jitter <RMS>	ps				Measured with SHF Pattern Generator with low jitter output option, precision timebase DCA. De-embedded from 40 Gbps NRZ electrical data source
NRZ			1.0	1.2	
RZ			0.4	0.5	
CS-RZ			0.4	0.5	
Position of crossing point @ NRZ	%	45	50	55	



DPSK mode operation					
Drive amplifier input level	Vpp (dBm)	0.36 (-5)		0.8 (2)	
Data					
Clock pulse RZ		0.5 (-2)	0.6 (0)	1.2 (6)	
Phase modulation by $2\sqrt{\pi}$ drive	Rad	0		π	
Auto-bias control (ABC)					
Dither signal frequency	kHz		10		

¹ (F. Devaux, Y. Sorel and J.F. Kerdiles, "Simple Measurement of Fiber Dispersion and of Chirp Parameter of Intensity Modulated Light Emitter", J. Lightwave Technol., vol. 11, no. 12, December 1993)

Absolute maximum ratings

Parameter	Unit	Min.	Typ.	Max.	Conditions
Optical input power	dBm			17	
NRZ data amplifier input power	dBm			10	NRZ data
RZ clock driver input power	dBm			10	CW

General specifications

Parameter	Unit	Min.	Typ.	Max.	Conditions
Weight	kg		3.3		
Dimensions	mm		59x213x450		w/o Frontpanel - Connectors
Power consumption	W		20.5		
Operating temperature	°C	10		35	
Electrical data input connector			V (1.85mm)		
Clock input connector			K (2.9mm)		
Optical connectors			FC/PC		



Test Measurements

The following equipment was used in obtaining these results:

SHF12100 A S/N 2 Pattern Generator

SHF 1550DFB Laser source set to 15mW output power @ 1550 nm.

AMPAQ EDFA + bandpass filter

Agilent 86100A DCA with 70GHz plugin and precision timebase module

ASK signals detected with 70 GHz photodetector; DPSK signals detected with SHF 5008 DPSK

Typical transmitter data input signal

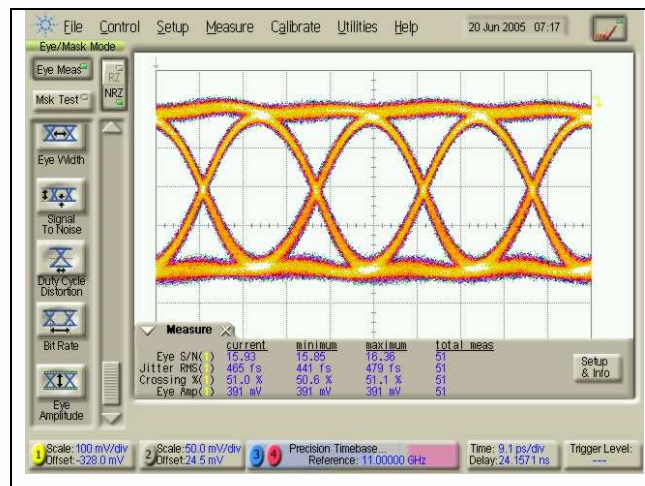

44 Gbps electrical signal. S/N: 15.9; RMS Jitter: 465 fs



Transmitter in ASK-mode

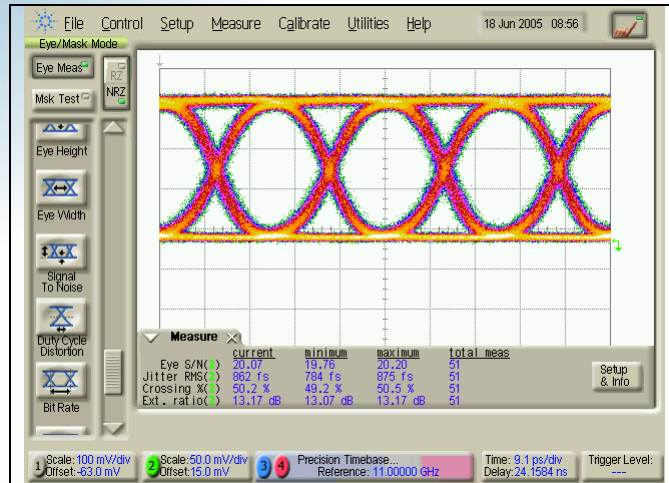

44 Gbps NRZ optical output signal. S/N: 20.1; RMS Jitter: 862 fs

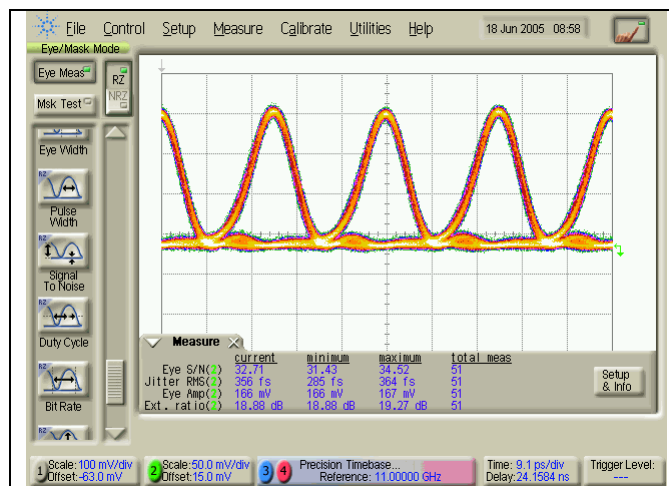

44 Gbps RZ optical output signal. S/N: 32.1; RMS Jitter: 356 fs

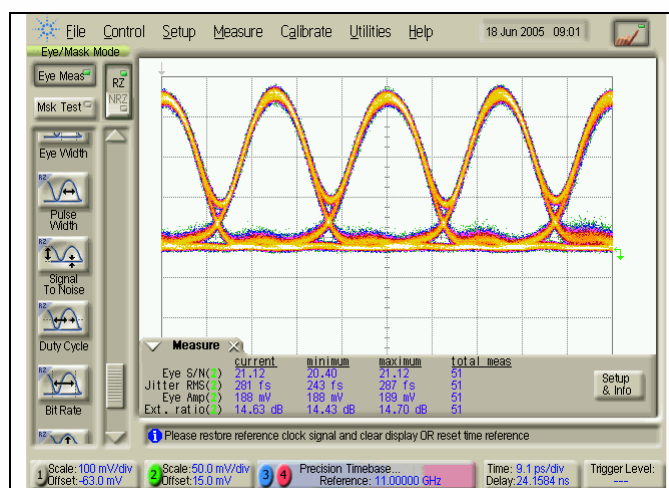

44 Gbps CS-RZ optical output signal. S/N: 21.2; RMS Jitter: 281 fs



Transmitter in DPSK mode

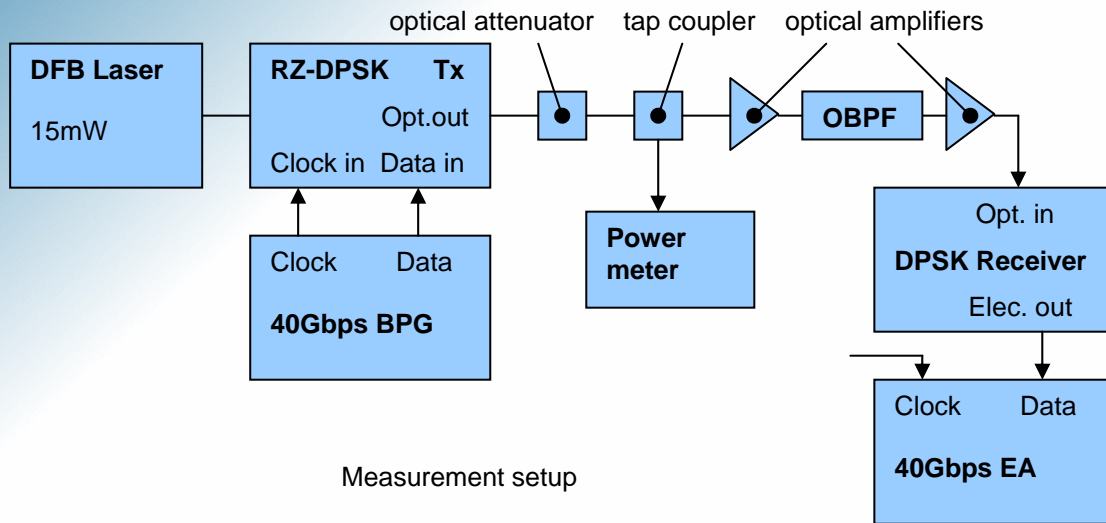

Receiver sensitivity

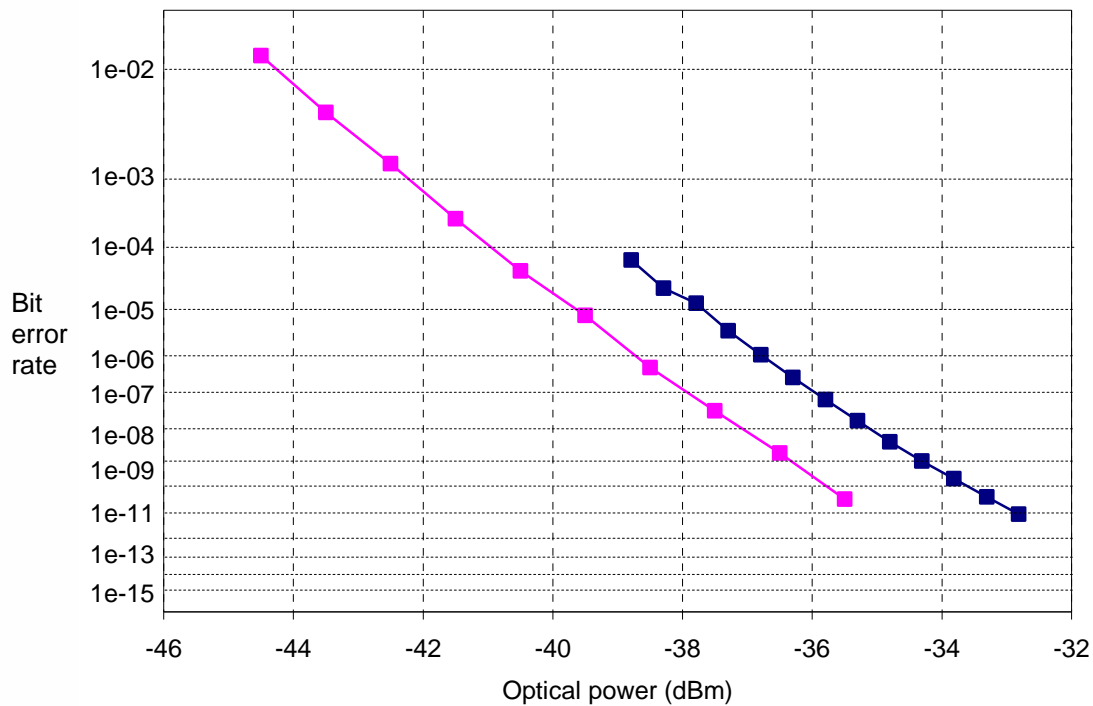

Two measurements made under different conditions.

Magenta (left): 40 Gbps with a 70 GHz optical bandpass filter and a preamp with 4dB noise figure. ~45 photons/bit

Blue (right): 42.4 Gbps with a 1.2nm optical bandpass filter and a preamp with 5.5dB noise figure. ~71 photons/bit

Sensitivity limit: 20 photons/bit



Eye diagrams

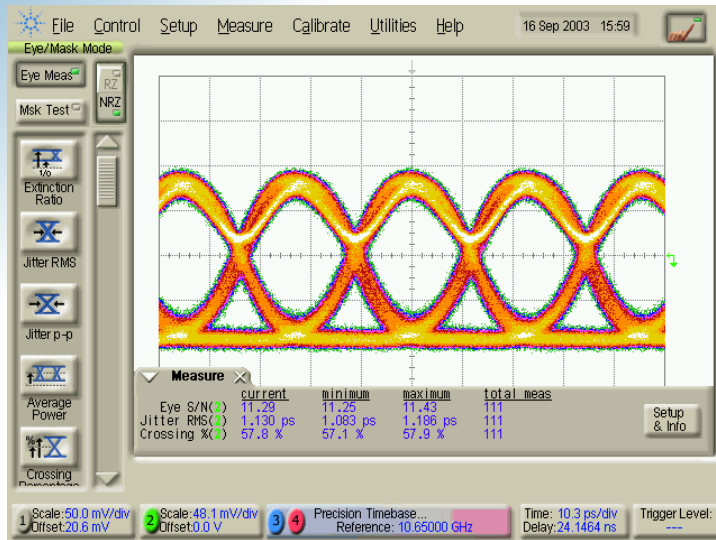

42.6 Gbps NRZ optical output signal. S/N: 11.3; RMS Jitter: 1.13 ps

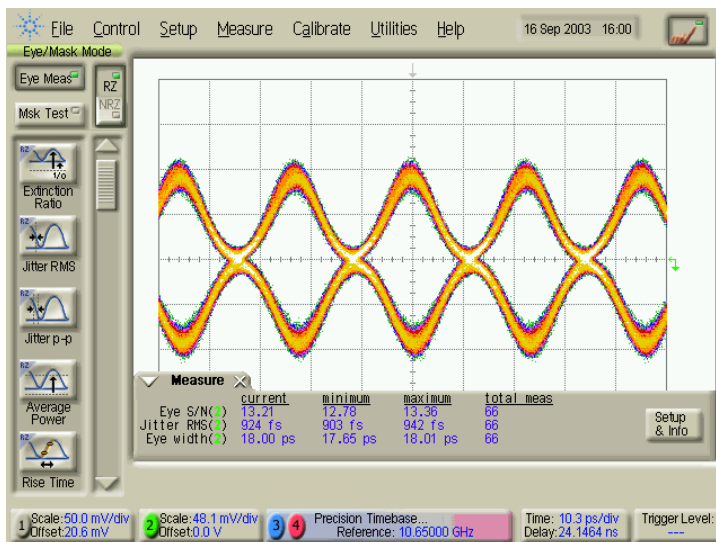

42.6 Gbps RZ optical output signal. S/N: 13.2; RMS Jitter: 924 fs

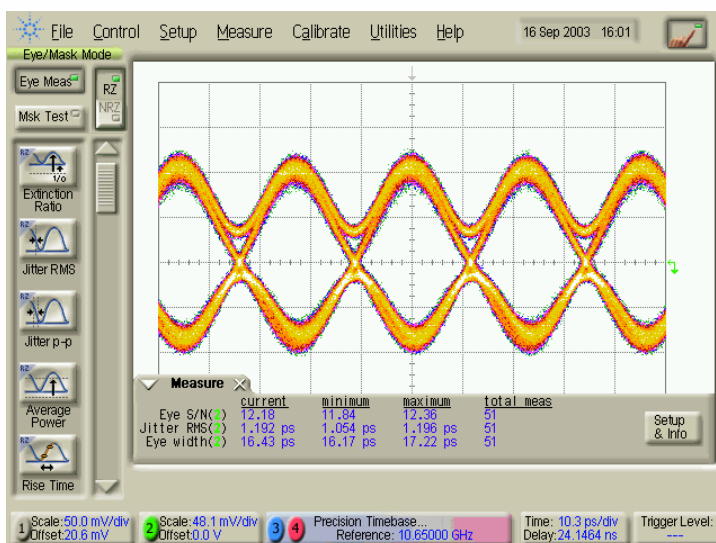

42.6 Gbps CS-RZ optical output signal. S/N: 12.2; RMS Jitter: 1.19 ps



Change note:

'46210A V1.1 -> '46210B V001

page 1: email adress, title

page 2: description

page 3: insertion loss

data rate limitation

page 3/4: data input sensitivity

page 4: Popt max 17 dBm