



SHF Communication Technologies AG

Wilhelm-von-Siemens-Str. 23D • 12277 Berlin • Germany

Phone ++49 30 / 772 05 10 • Fax ++49 30 / 753 10 78

E-Mail: sales@shf.de • Web: <http://www.shf.de>

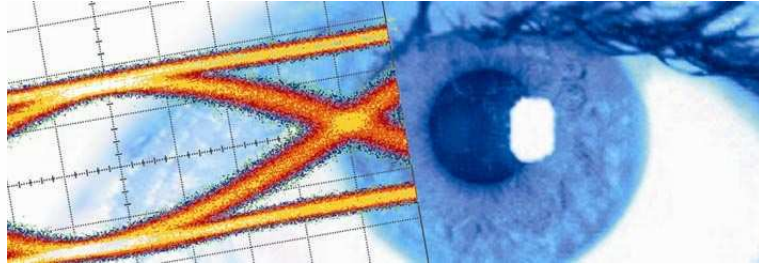

Preliminary Datasheet

SHF 404 Mux

60 Gbps Multiplexer Module

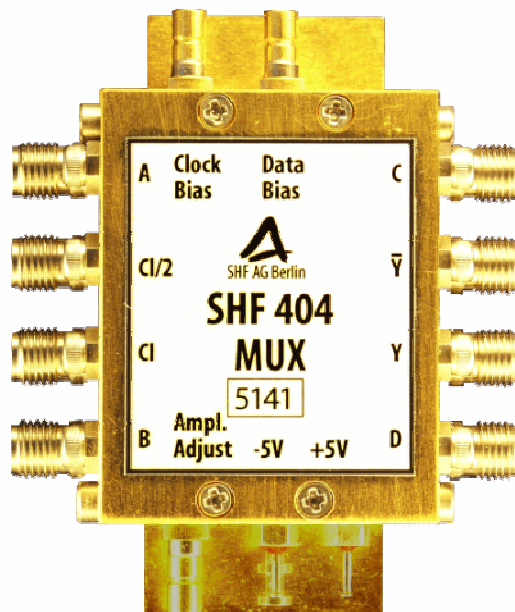



Description

The SHF 404 MUX is a 4:1 multiplexer which operates at data rates up to 60 Gbps for use in SONET OC-768 and SDH STM-256 applications, broadband test setups and telecom transmission systems. Four single ended data channels are accepted by the multiplexer at a nominal input data rate of 15 Gbps and combined into a 60 Gbps differential serial data stream. A single ended clock signal (nominally 30 GHz) with a frequency of half the output data rate drives the SHF 404 MUX and a copy of the divided input clock at a nominal frequency of 15 GHz is provided as an output signal to drive preceding circuits or pattern generators. For extra flexibility, the output amplitude of the multiplexer can be adjusted between 200 mV and 400 mV. Data and clock outputs are DC-coupled ground referenced CML signals with on-chip 50 Ω terminations. The data and clock inputs are AC-coupled and also include 50 Ω terminations.

Features

- SiGe HBT technology
- Supports output data rates from 2 Gbps up to 60 Gbps
- Optimized performance for operation from 38 Gbps to 56 Gbps
- Low power consumption: 3.5 W typ.
- Single ended AC-coupled inputs 400...1000 mV
- Dual power supply with internal voltage regulator ± 5 V
- V-type connectors for the 60 Gbps outputs
- K-type connectors for the data inputs and clock in/outputs
- SMB-type connectors for the clock/data bias and amplitude adjust inputs
- Adjustable output amplitude

Applications

- SONET OC-768 and SDH STM-256 applications
- Broadband test setups
- Telecom transmission systems prototyping

Option

- Option BA: two potentiometers to allow clock bias and output amplitude to be adjusted without the need for additional power supplies.

Functional block diagram

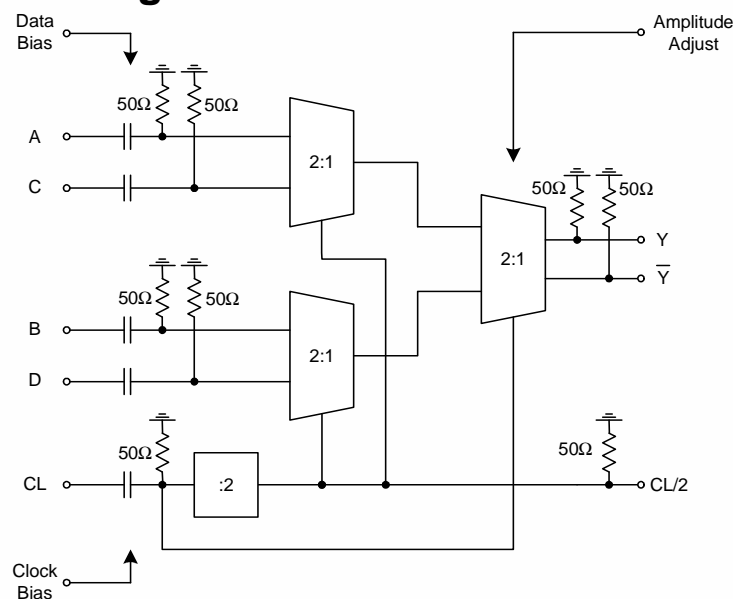



Specifications – SHF 404 MUX

Parameter	Unit	Min.	Typ.	Max.	Conditions
Input parameters					
Data rate	Gbps	0.5		15	
Eye amplitude	mV	400		1000	
Return loss	dB			-10	
Output parameters					
Data bit rate ¹	Gbps	2		60	
Voltage high level	mV		0		single ended
Voltage low level	mV		-400	-300	single ended
Eye amplitude	mV	300	400		single ended
Rise time	ps		9		(20%...80%)
Fall time	ps		9		(20%...80%)
RMS jitter	fs	400	450	500	
Return loss	dB			-10	
Clock parameters					
Input level	mV	400		1000	
Input return loss	dB			-10	
Clock/2 output level	mV	300	350		
Clock/2 output return loss	dB			-10	
Power requirements					
Negative supply voltage	V	-6.5		-5.0	
Negative supply current	mA	600	650	700	
Positive supply voltage	V	+5.0		+6.5	
Positive supply current	mA		20		
Total power dissipation	W		3.5		

Please note: SHF also supplies adjustable delay lines for clock-data alignment purpose. See SHF application note AN404-1 for 4:1 multiplexing operation setup.

¹ Optimized performance for operation from 38 Gbps to 56 Gbps



Output waveforms

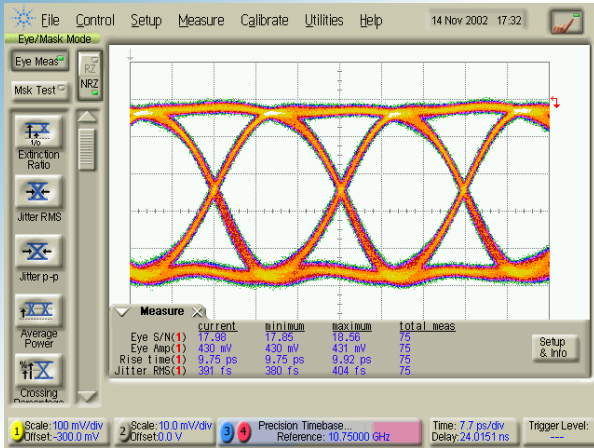

Eye diagram at 43 Gbps, PRBS 2³¹-1

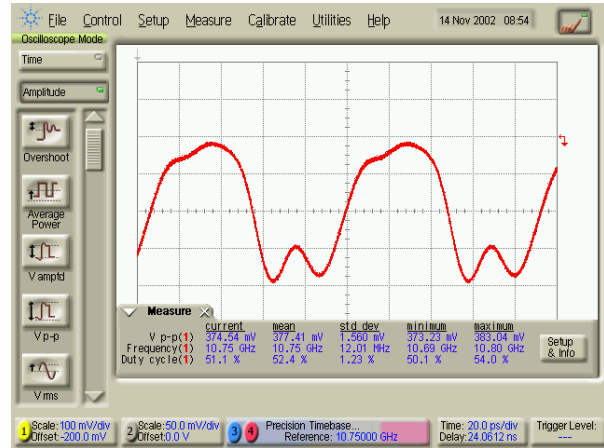

Clock/2 output at 43 Gbps output data rate

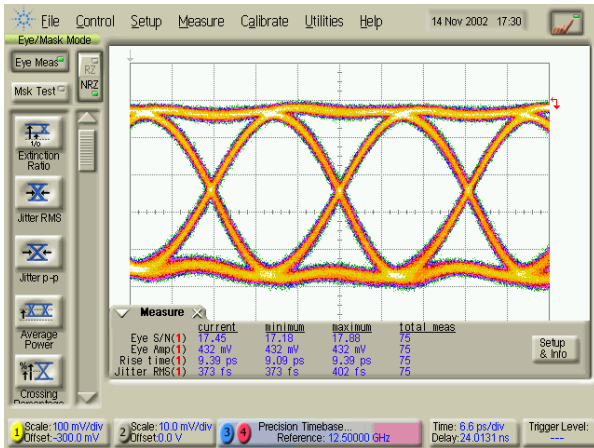

Eye diagram at 50 Gbps, PRBS 2³¹-1

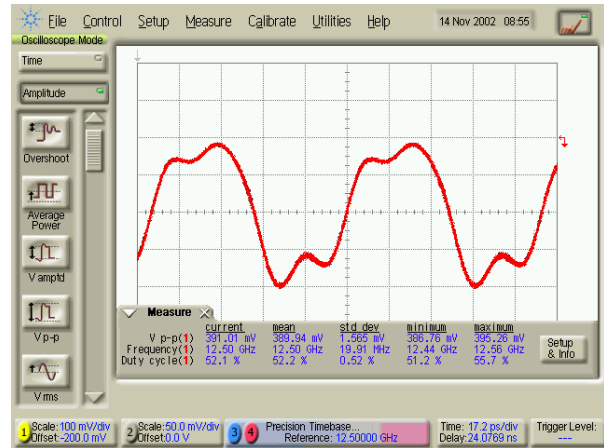

Clock/2 output at 50 Gbps output data rate

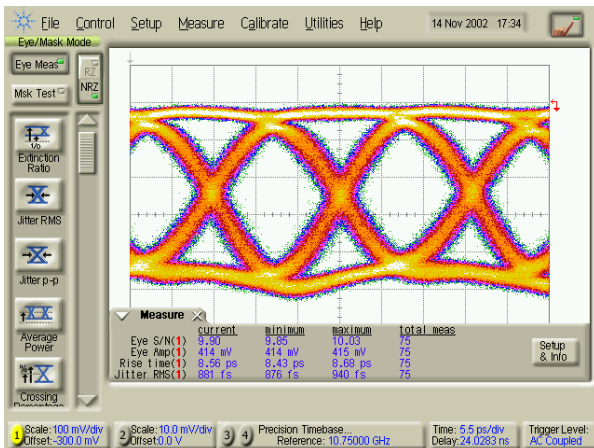

Eye diagram at 60 Gbps, PRBS 2³¹-1

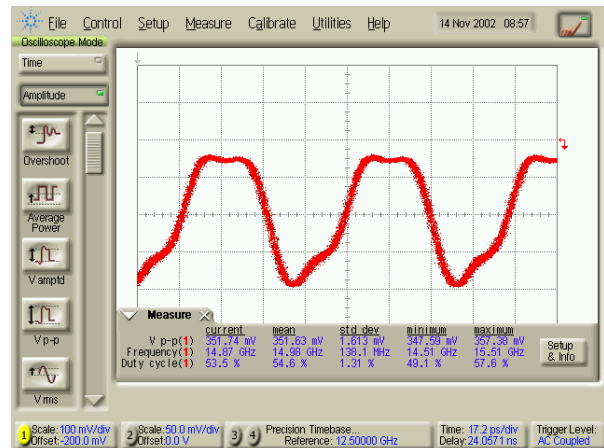

Clock/2 output at 60 Gbps output data rate

Measured using Agilent DCA 86100B, sampling module 86118A [70 GHz], precision timebase module 86107A, 0.5 m microwave cable assembly, 10 dB attenuator



Amplitude adjust at 50 Gbps

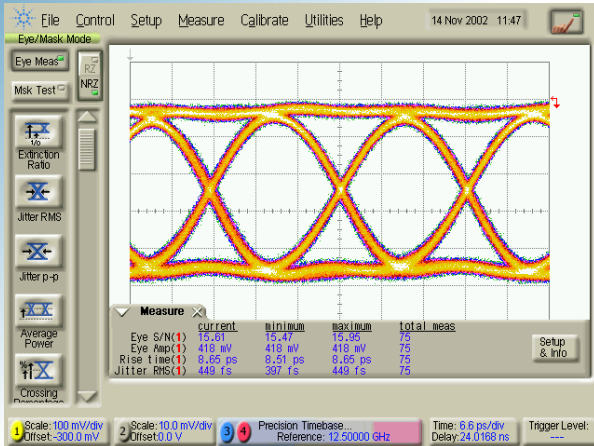

Amplitude adjust = 5 V; Output = 418 mV

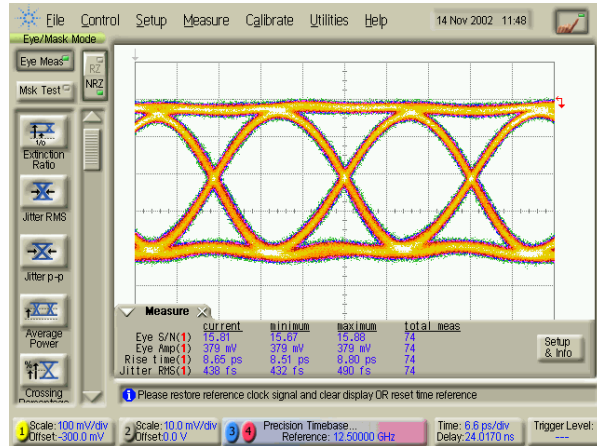

Amplitude adjust = 4 V; Output = 379 mV

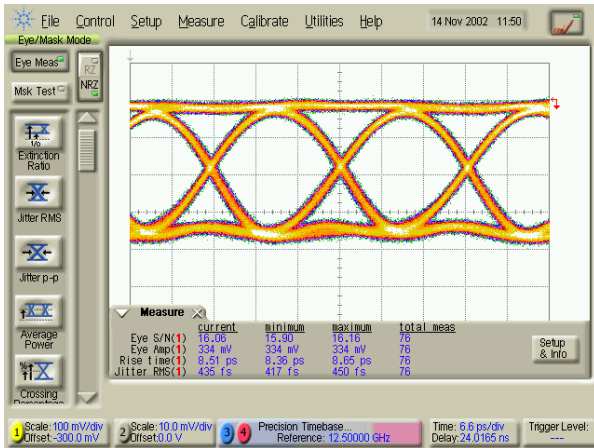

Amplitude adjust = 3 V; Output = 334 mV

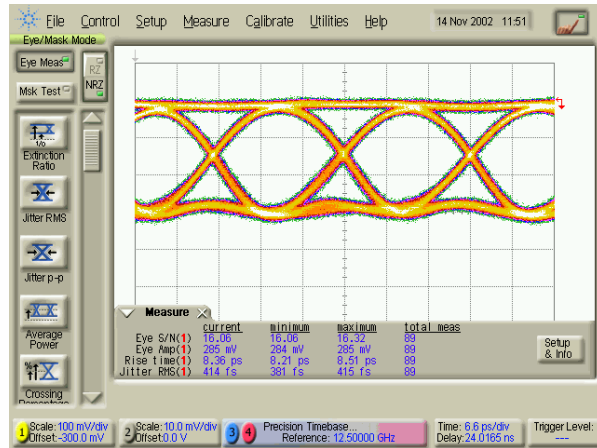

Amplitude adjust = 2 V; Output = 285 mV

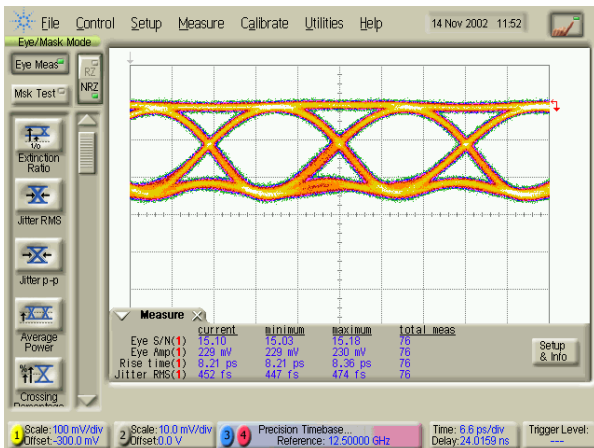

Amplitude adjust = 1 V; Output = 229 mV

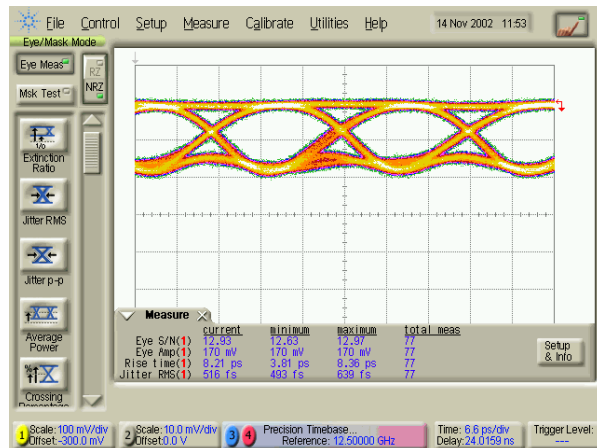

Amplitude adjust = 0 V; Output = 170 mV

Measured using Agilent DCA 86100B, sampling module 86118A [70 GHz], precision timebase module 86107A, 0.5 m microwave cable assembly, 10 dB attenuator



Module outline

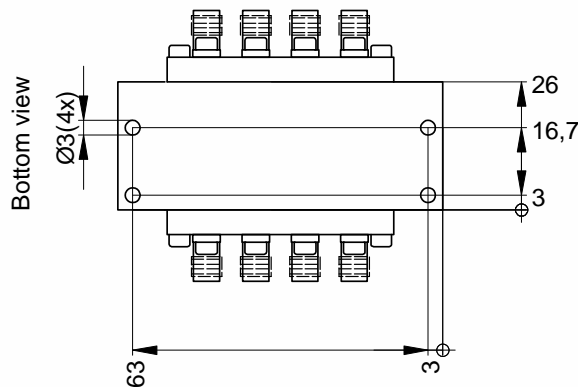
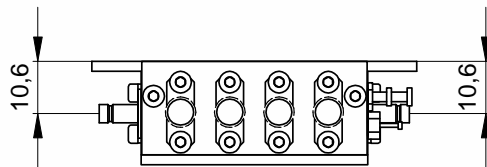
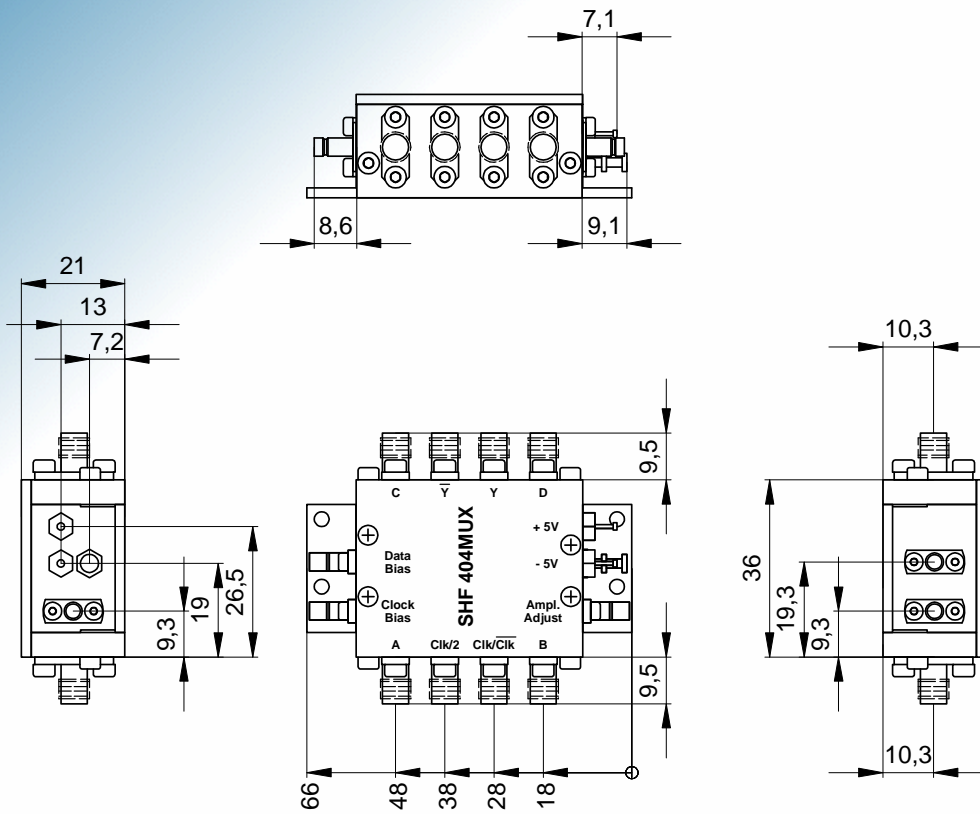

Port	Connector
A	K
B	K
C	K
D	K
Clk	K
Clk/2	K
Y	V
-Y	V
Clock Bias	SMB
Data Bias	SMB
Amplitude Adjust	SMB

Please ensure that adequate cooling of the multiplexer is guaranteed. We recommend a heat sink with a thermal resistance of approx. 3 K/W

All dimensions in mm