



## SHF Communication Technologies AG

Wilhelm-von-Siemens-Str. 23D • 12277 Berlin • Germany

Phone +49 30 772 051-0 • Fax +49 30 753 10 78

E-Mail: [sales@shf-communication.com](mailto:sales@shf-communication.com) • Web: [www.shf-communication.com](http://www.shf-communication.com)

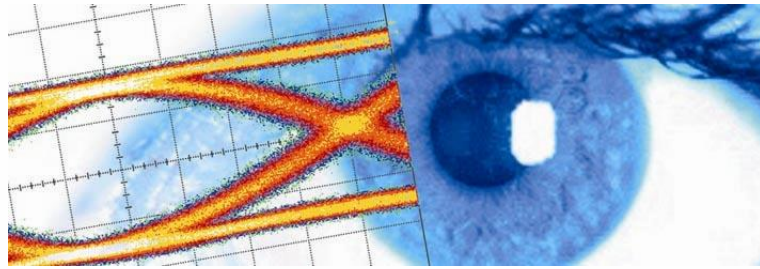

# Datasheet

## SHF S824 A

### Broadband Linear Amplifier

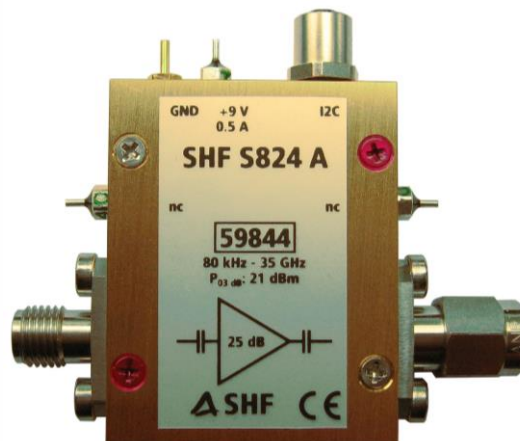



## Description

The S824 A is a two-stage amplifier design, using proprietary monolithic microwave integrated circuits (MMICs) inside special carriers to achieve ultra-wide bandwidth and low noise performance. An internal voltage regulation protects the amplifier against accidental reverse voltage connection and makes it robust against line voltage ripple.

A feature has been built-in to enable the amplifier gain and crossing to be controlled externally via software.

## Ease of Use

Upon delivery, the amplifier is already pre-set to deliver maximum gain, maximum output amplitude and nominally 50% crossing.

These settings can be modified in an easy to use graphical software interface, as shown below. For connecting the amplifier to the computer, the USB to I2C converter cable, as well as the required software are included with each amplifier with no extra charge.

Once new settings are stored on the device the amplifier will remember the settings until further changes are made. There is no need to connect a computer to the device unless gain, maximum amplitude or crossing adjustments are to be made.

The software is available for download at [www.shf-communication.com/software](http://www.shf-communication.com/software).



GUI of the SHF amplifier control software V1.6

## Available Options

- 01: DC return on input (max.  $\pm 1.75$  V, max. 35 mA)<sup>1</sup>
- 02: Built-in bias tee on input (max.  $\pm 9$  V, max. 200 mA)<sup>1</sup>
- 03: DC return on output (max.  $\pm 1.75$  V, max. 35 mA)<sup>1</sup>
- 04: Built-in bias tee on output (max.  $\pm 5$  V, max. 200 mA)<sup>1</sup>
- MP: Matches the phase of two amplifiers
- DHS: Dual Heat Sink, two amplifiers on one heatsink

<sup>1</sup> The options 01 & 02 or 03 & 04 cannot be combined.

If an option is chosen, gain and output power might be reduced by up to 1 dB and the low frequency 3 dB point might be increased up to 90 kHz. The DC resistance of a bias tee is about 4  $\Omega$ .



## Specifications – SHF S824 A

Parameter	Unit	Symbol	Min	Typ	Max	Conditions
<b>Absolute Maximum Ratings</b>						
Maximum RF Input Power in Operation	dBm V	$P_{in\ max}$			4 1	peak to peak voltage
Maximum RF Input Power without Power Supply	dBm V	$P_{in\ max}$			10 2	peak to peak voltage
DC Voltage at RF Input	V				±9	AC coupled input
DC Voltage at RF Output	V				±5	AC coupled output
Supply Voltage	V		8.5		12	0.4 A, reverse voltage protected
Case Temperature <sup>2</sup>	T <sub>case</sub>	°C	10	40	55	

<sup>2</sup> If operated with heat sink (part of the delivery) at room temperature there is no need for additional cooling.



Parameter	Unit	Symbol	Min	Typ	Max	Conditions
<b>Electrical Characteristics</b> (At 40°C case temperature, unless otherwise specified)						
High Frequency 3 dB Point	GHz	f <sub>HIGH</sub>	35			
Low Frequency 3 dB Point	kHz	f <sub>LOW</sub>			80	
Gain	dB	S <sub>21</sub>	25			Non-inverting ; measured at P <sub>in</sub> =-30 dBm ; Average 40 MHz ... 500 MHz
Max. Gain Reduction	dB		2.5	3	4	
Output Power at 1 dB Compression	dBm V	P <sub>01dB</sub>	18 5			10 MHz...15 GHz peak to peak voltage
Output Power at 2 dB Compression	dBm V	P <sub>02dB</sub>	19.5 5.9			10 MHz...15 GHz peak to peak voltage
Output Power at 3 dB Compression	dBm V	P <sub>03dB</sub>	21 7.1			10 MHz...15 GHz peak to peak voltage
Crossing Control Range	%		-5		5	at 5 Vpp
Input Reflection	dB	S <sub>11</sub>			-12 -9	< 5 GHz < 30 GHz
Output Reflection	dB	S <sub>22</sub>			-10	< 30 GHz
Rise Time/Fall Time	ps	t <sub>r</sub> /t <sub>f</sub>			12 15	Deconvoluted <sup>3,4</sup> ; 20%...80% Full Setup <sup>3</sup> ; 20%...80%
Jitter	fs	J <sub>RMS</sub>		400 500	630 700	Deconvoluted <sup>3,4</sup> Full Setup <sup>3</sup>
Group Delay Ripple	ps				±50	40 MHz...30 GHz, 160 MHz aperture
Power Consumption	W			3.6		9 V / 0.4A
<b>Mechanical Characteristics</b>						
Input Connector	Ω			50		2.92 mm (K) female <sup>5</sup>
Output Connector	Ω			50		2.92 mm (K) male <sup>5</sup>
Dimensions	mm					please see pages 10 to 12
Weight	g			30 240 290		without heat sink with single heat sink DHS: two amplifier on one heat sink

<sup>3</sup> Measured with the following setup: SHF DAC 613 A -> DUT (SHF S824 A) -> Agilent 86100D with 70 GHz sampling head and precision time base.

<sup>4</sup> Calculation based on typical results of setup without DUT :

$$t_r/t_f \text{ deconvoluted} = \sqrt{(t_r/t_f \text{ full setup})^2 - (t_r/t_f \text{ setup w/o DUT})^2} = \sqrt{(t_r/t_f \text{ full setup})^2 - 11 \text{ ps}^2}$$

$$J_{RMS} \text{ deconvoluted} = \sqrt{(J_{RMS} \text{ full setup})^2 - (J_{RMS} \text{ setup w/o DUT})^2} = \sqrt{(J_{RMS} \text{ full setup})^2 - 300 \text{ fs}^2}$$

<sup>5</sup> Other gender configurations are available on request.



# Typical S-Parameters, Group Delay and Phase Response

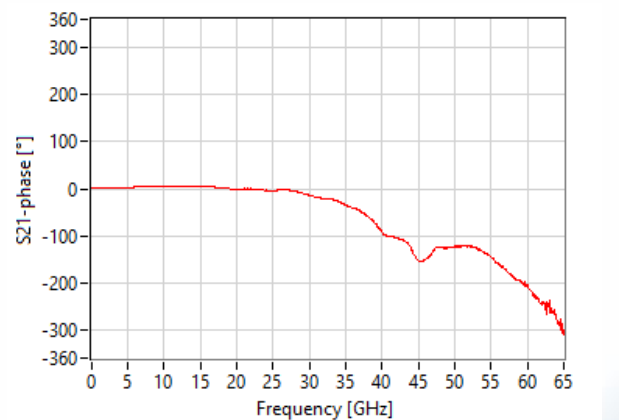
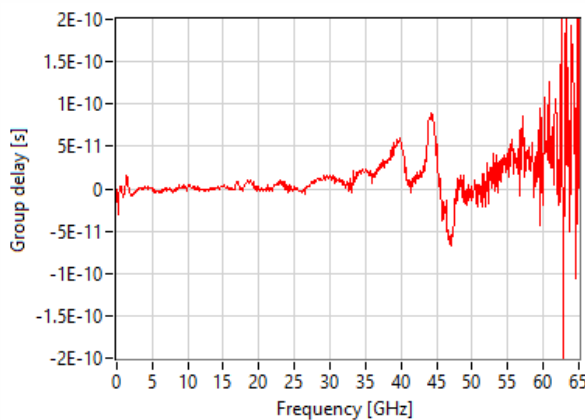
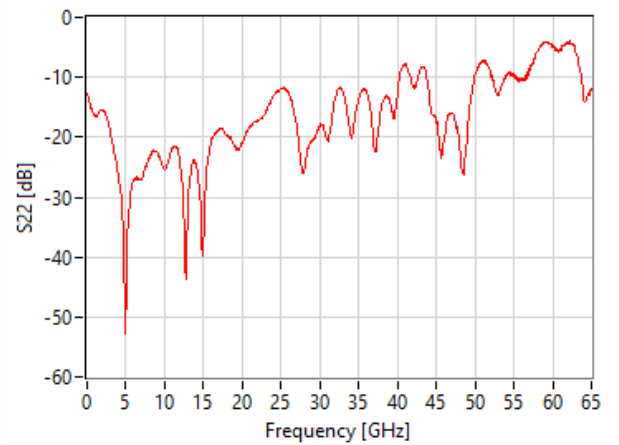
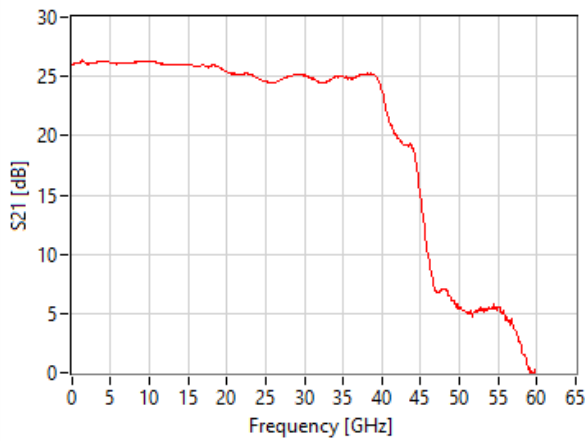
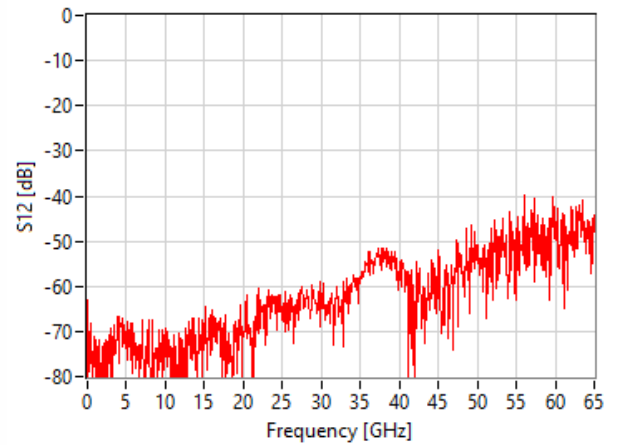
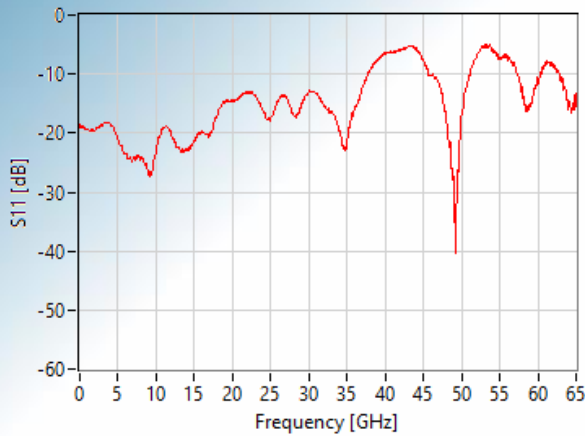

Aperture of group delay measurement: 160 MHz



## Typical Noise Figure

The measurement had been performed using a FSW85 Spectrum Analyzer by Rhode & Schwarz. The noise figure defines the degradation of the signal-to-noise ratio when the signal passes the amplifier. An ideal amplifier would amplify the noise at its input along with the signal. However, a real amplifier adds some extra noise from its own components and degrades the signal-to-noise ratio. Please note that this applies to small signals only. When the amplifier is used close to or in its saturation region additional non-linear effects will impact the signal-to-noise ratio and the signal waveform.

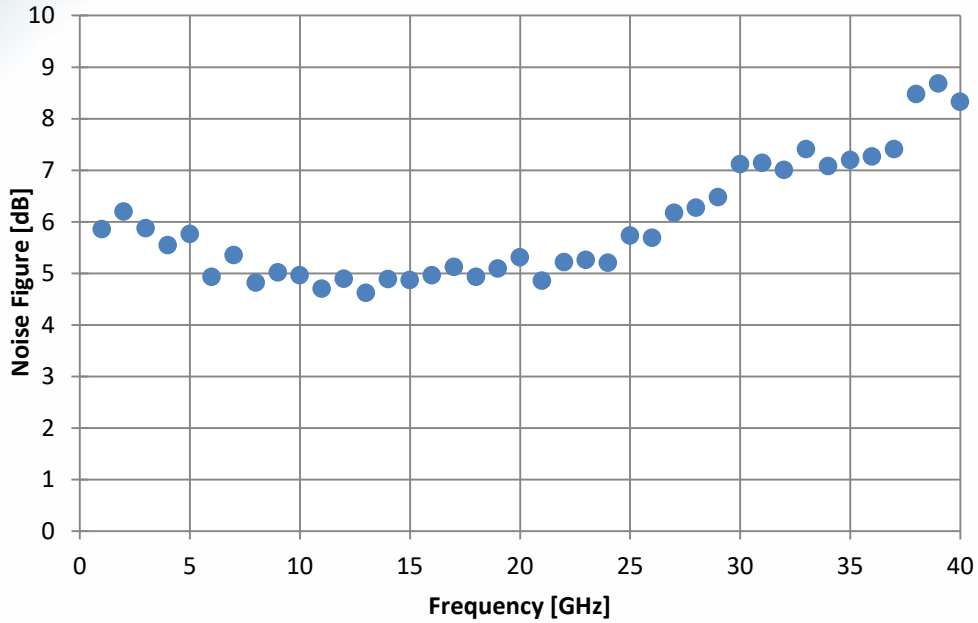



## Typical Binary Waveforms

Measurements at 32 Gbps had been performed using a SHF 613 A DAC and an Agilent 86100D DCA with Precision Time Base Module (86107A) and 70 GHz Sampling Head (86118A).

The measurement at ~ 5 V will be part of the inspection report delivered with each particular device.

### Eye Amplitudes: Input ~270 mV ⇒ Output ~5 V

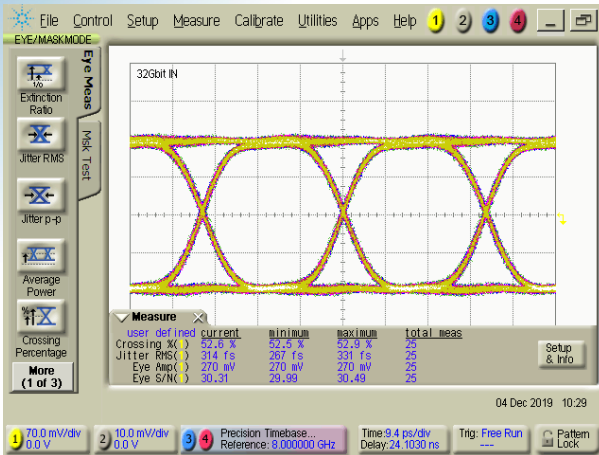

Input Signal @ 32 Gbps

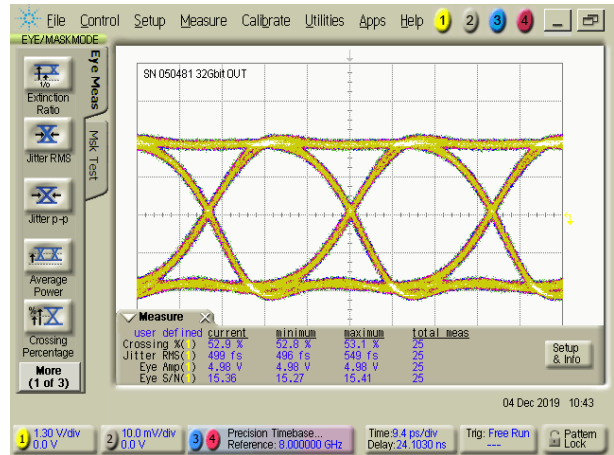

Output Signal @ 32 Gbps

Measurements at 32 Gbps had been performed using a SHF 12103 A BPG and an Agilent 86100D DCA with Precision Time Base Module (86107A) and 70 GHz Sampling Head (86118A).

### Eye Amplitudes: Input ~470 mV ⇒ Output ~7 V

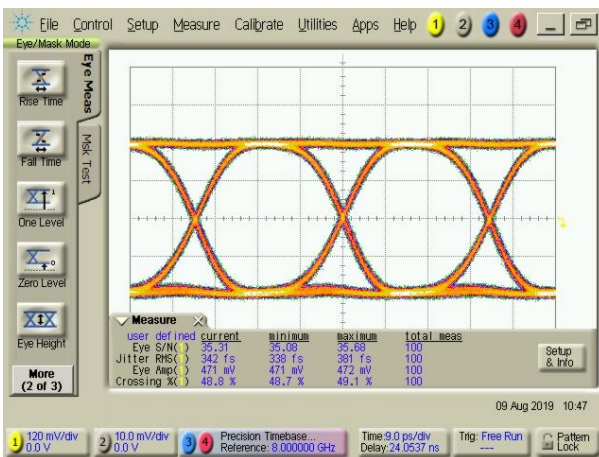

Input Signal @ 32 Gbps, ~470 mVpp

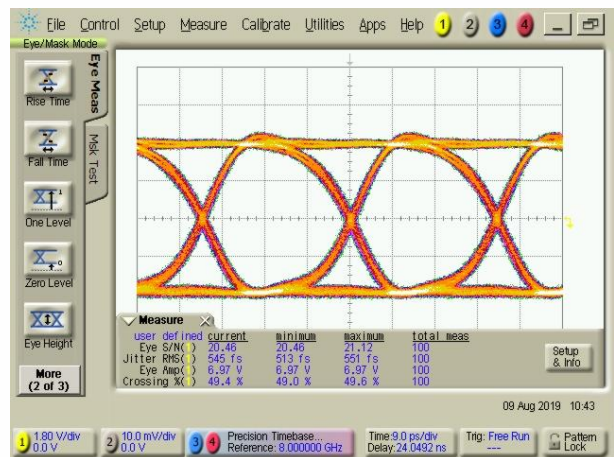

Output Signal @ 32 Gbps, ~7 Vpp



## Typical 4-Level Waveforms

Measurements at 32 GBaud had been performed using a SHF 613 A DAC and an Agilent 86100D DCA with Precision Time Base Module (86107A) and 70 GHz Sampling Head (86118A).

This measurement will be part of the inspection report delivered with each particular device.

**Eye Amplitudes: Input ~280 mV ⇒ Output ~5 V**

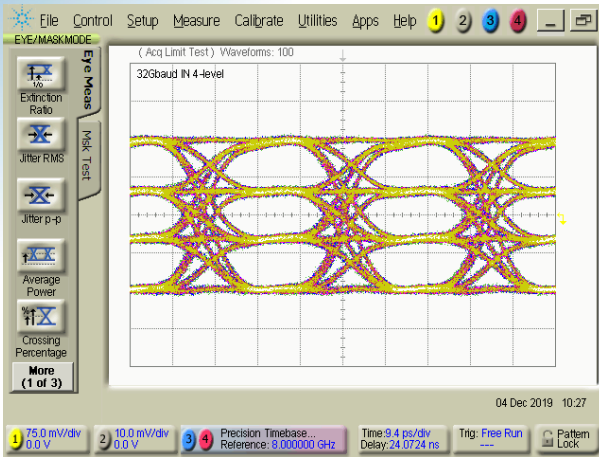

**Input Signal @ 32 GBaud**

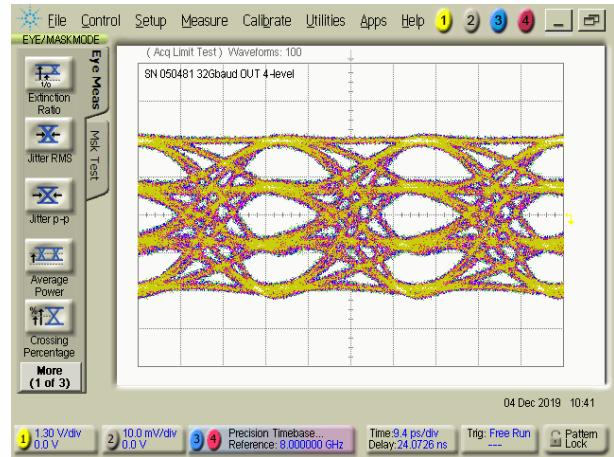

**Output Signal @ 32 GBaud**





## Typical Low Frequency Response (<40 MHz)

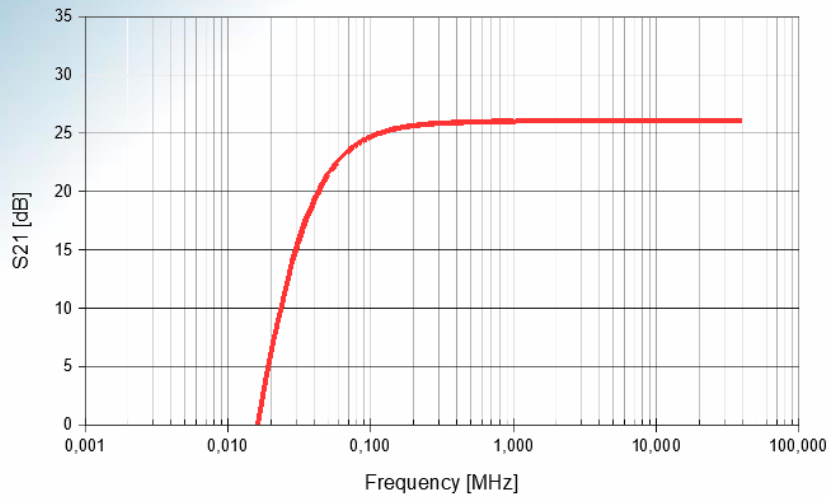

## Typical Saturation power

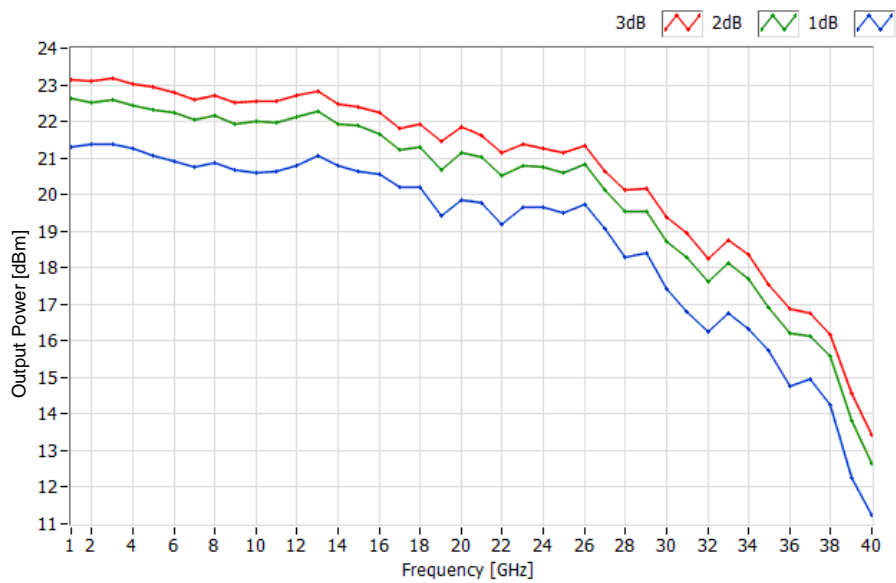

**Top (red): 3 dB compression;**  
**Middle (green): 2 dB compression;**  
**Bottom (blue): 1 dB compression**



# Mechanical Drawing with Heat Sink

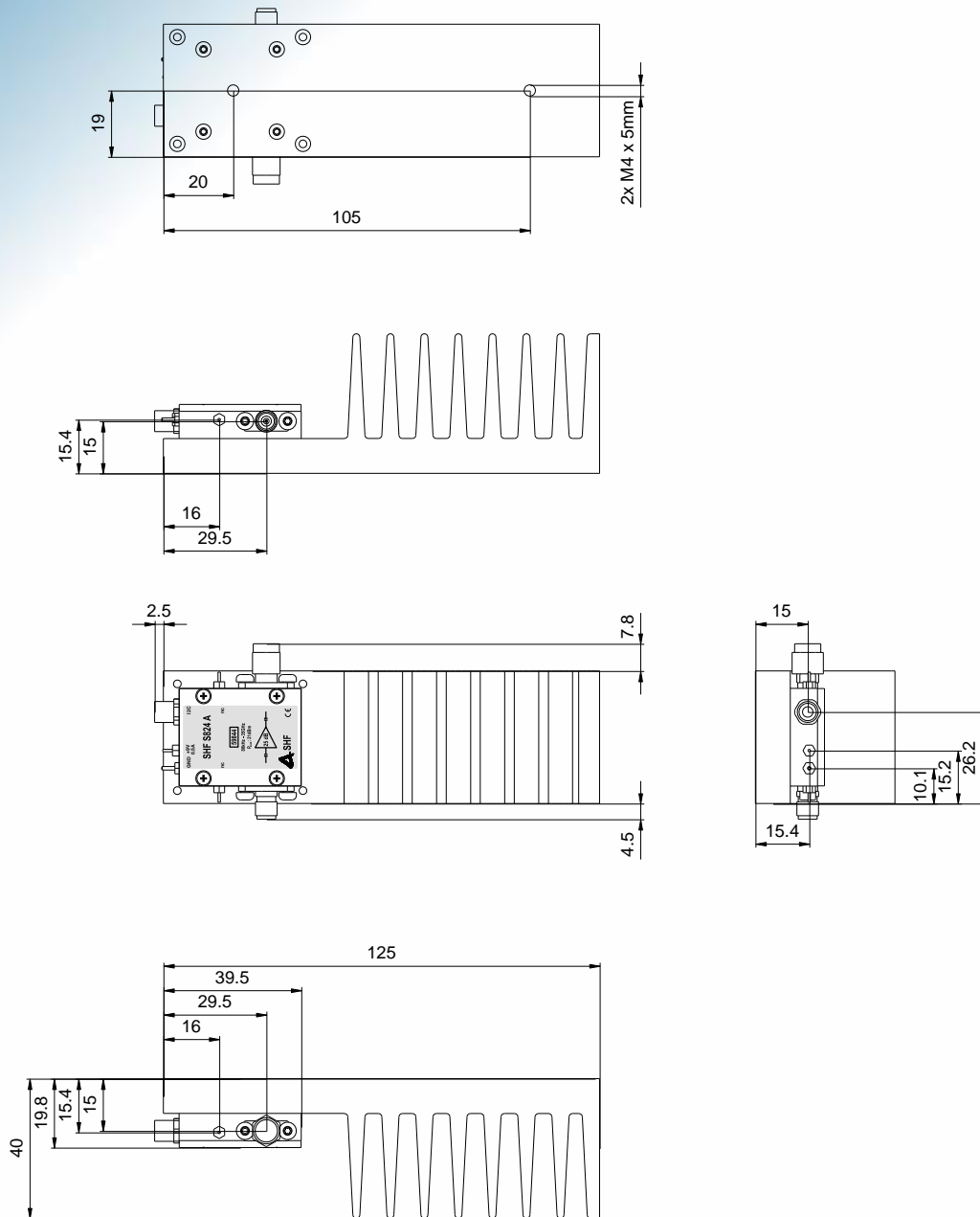

all dimensions in mm

Pin assignment might change if a bias tee option is chosen.

Thermal resistance of heat sink approx. 4 K/W

For permanent mounting remove the heat sink from the amplifier. In that case please ensure that adequate cooling of the amplifier is guaranteed. It is recommended to use thermal paste or a thermal gap pad for the mounting. In order to separate the heat sink from the amplifier, remove the four screws on the heat sink. Please note, thermal paste is used between the heat sink and the amplifier housing.



# Mechanical Drawing with Heat Sink Option DHS

Dual Heat Sink, two amplifiers on one heatsink

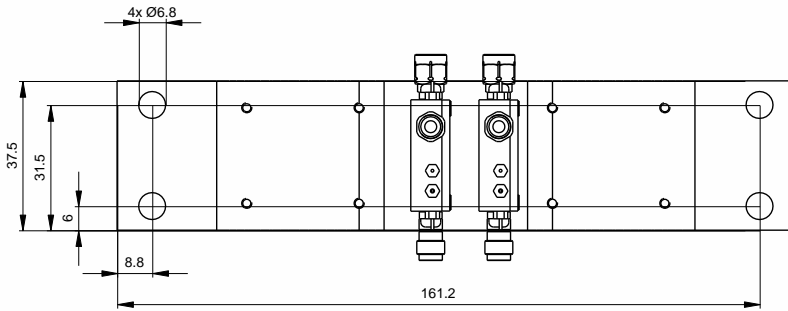
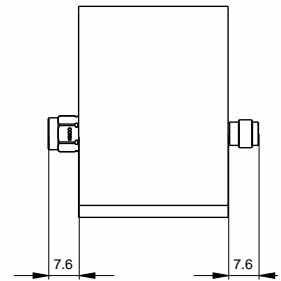
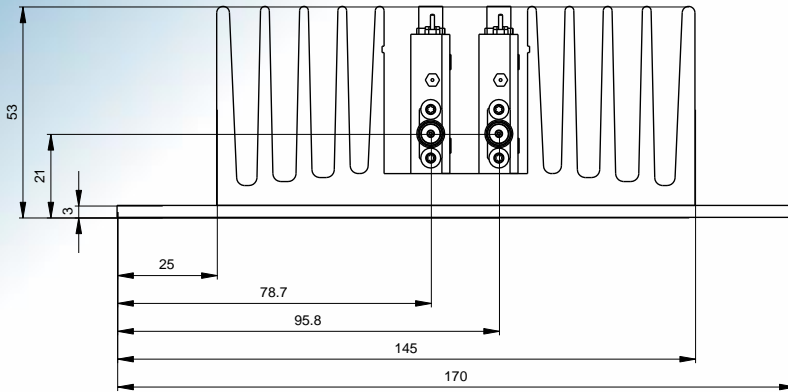



# Mechanical Drawing without Heat Sink

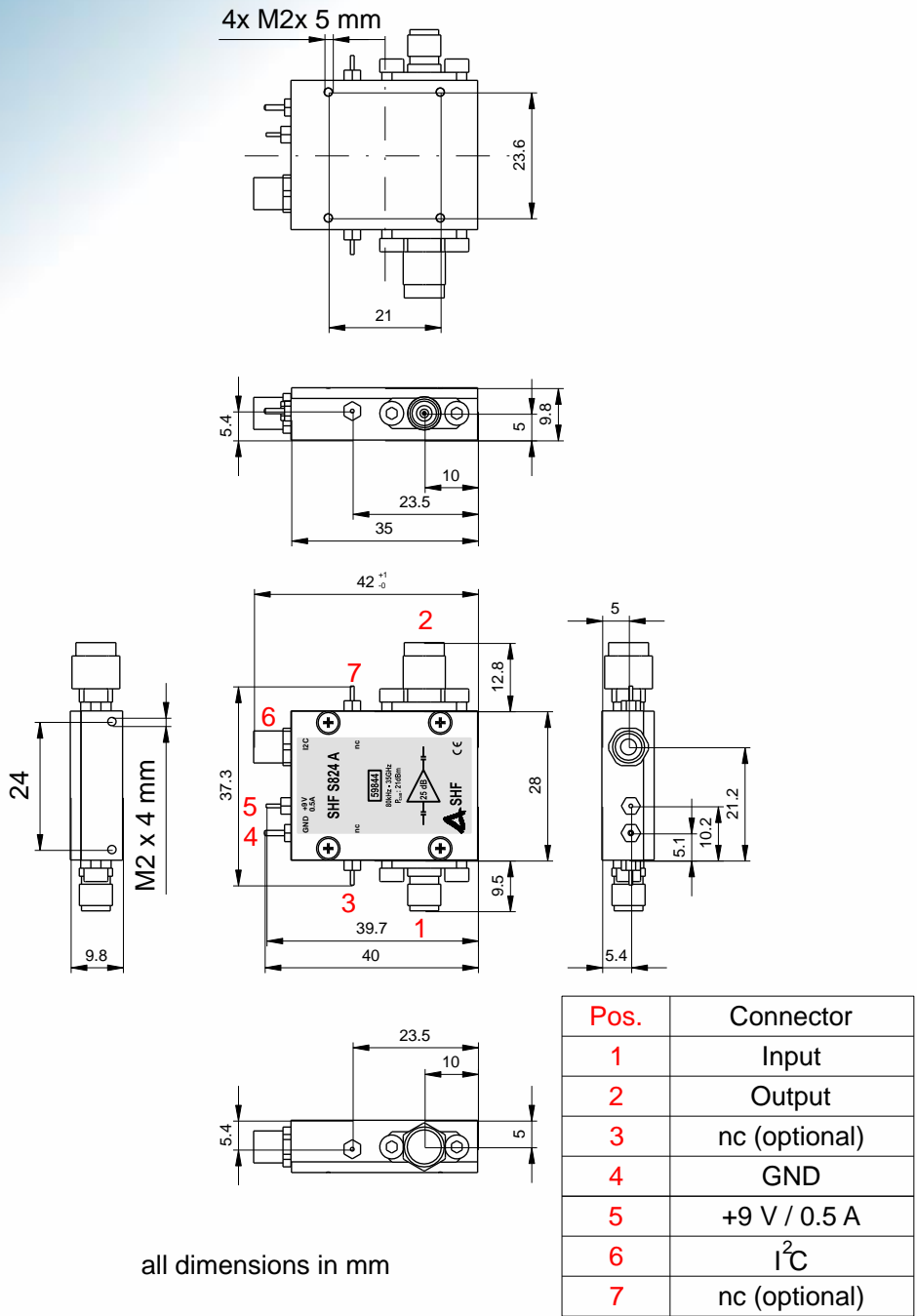

In standard configuration pin 3 and 7 are not connected (nc). If an input bias-tee (option 02) is included the DC bias can be connected to pin 3. If an output bias-tee (option 04) is included the DC bias can be connected to pin 7.

Please ensure that adequate cooling of the amplifier is guaranteed.



## User Instructions

### ATTENTION!

#### Electrostatic sensitive GaAs FET amplifier

1. To prevent damage through static charge build up, cables should be always discharged before connecting them to the amplifier!
2. Attach a 50 Ohm output load before supplying DC power to the amplifier!
3. The supply voltage can be taken from any regular 8.5 ...12 V, (0.5 A @ 9V) DC power supply and can be connected to the supply feed-through filter via an ON / OFF switch.  

In case 9 V are applied to the amplifier typically 0.4 A are drawn during operation. However, the amplifier requires more current during start up. This is particularly important in case the current compliance of a very fast acting voltage source is set too tight. As this can prevent the amplifier from starting properly, please allow up to 100% overhead for your current compliance during startup.
4. Using a 3 dB or 6 dB input attenuator will result in a 6 dB or 12 dB increase of the input return loss. For minimal degradation of amplifier rise time, these attenuators should have a bandwidth specification of greater 40 GHz (K / 2.92 mm attenuators)!
5. A input signal of about 0.55 Vpp will produce output swing of about 7 Vpp. Higher input voltages are leading to waveform degradation.
6. The amplifier can only be used without damage by connecting a 50 Ohm precision load to the output.
7. ATTENTION: At radio frequencies a capacitive load can be transformed to an inductive one through transmission lines! With an output stage driven into saturation this may lead to the immediate destruction of the amplifier (within a few ps)!
8. The input voltage should never be greater than 1 Vpp equivalent to 4 dBm input power.
9. In case a bias tee is connected to the amplifier, please note that abrupt connection or disconnection of the RF port of such bias tees may cause harmful transients. Therefore, it is always recommended not to connect or disconnect bias tees under bias voltage. For example, ramp down the bias to 0 V before lifting a waver prober.
10. For the DC-connections flexible cable 0.2...0.5 mm<sup>2</sup> / AWG 24...20 are recommended. A maximum soldering temperature of 260 °C for 3 seconds is recommended for the feedthrough (positive supply voltage and bias tee pin). The ground pin requires significantly more heat as it is connected to the solid housing.