



SHF Communication Technologies AG

Wilhelm-von-Siemens-Str. 23D • 12277 Berlin • Germany

Phone +49 30 772 051-0 • Fax +49 30 753 10 78

E-Mail: sales@shf.de • Web: <http://www.shf.de>

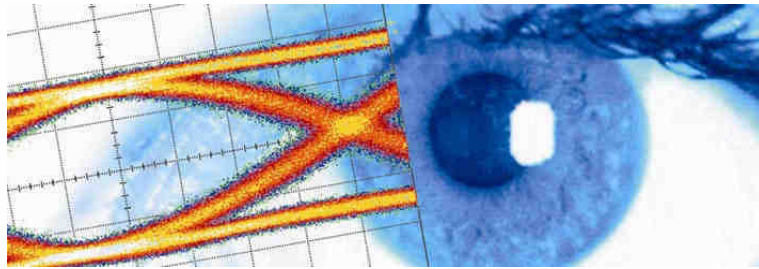

Datasheet

SHF M834 A

Broadband Linear Amplifier

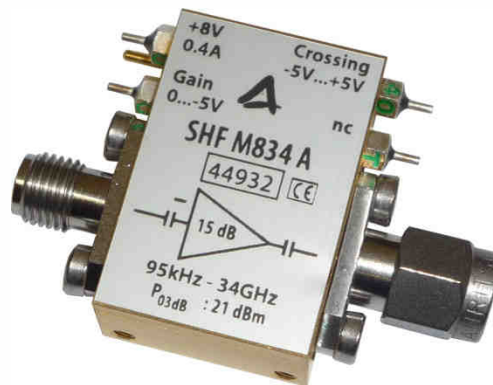



Description

The SHF M834 A is a broadband RF amplifier with a small footprint, 15 dB small signal gain and a bandwidth of more than 34 GHz. In addition, it exhibits excellent amplitude linearity (P1dB) in excess of 4Vpp. These characteristics offers the capability to amplify binary signals of more than 32 Gbps while the high amplitude linearity enables this amplifier to drive modulators and lasers for PAM, optical QAM, OFDM and analog signals.

A single stage amplifier design is employed using our monolithic microwave integrated circuit (MMIC) inside special carriers to achieve the bandwidth and the low noise performance.

Ease of Use

Only a single 8 V supply is needed for operation.

Upon delivery, the amplifier is already set to deliver maximum gain and 50% crossing. For operation under these conditions the appropriate pins can be left floating. However, in case gain and crossing shall be modified, this can be done just by applying another bias.

Applications

- Optical Communications
- High-Speed Pulse Experiments
- Satellite Communications
- Research and Development
- Antenna Measurements
- Data Transmission

Available Options

01: DC return on input (max. ± 1.75 V, max. 35 mA)¹

02: Built-in bias tee on input (max. ± 12 V, max. 200 mA)¹

03: DC return on output (max. ± 1.75 V, max. 35 mA)¹

04: Built-in bias tee on output (max. -5...+12 V, max. 200 mA)¹

MP: Matches the phase of two amplifiers

¹ The options 01 & 02 or 03 & 04 cannot be combined.

If an option is chosen, the maximum gain and the maximum output power might be reduced by up to 1 dB. The low frequency 3 dB Point might be increased up to 100 kHz. The DC resistance of an bias tee is about 6 Ω .



Specifications - SHF M834 A

Parameter	Unit	Symbol	Min	Typ	Max	Conditions
Absolute Maximum Ratings						
Maximum RF Input	dBm V	$P_{in\ max}$			10 2	peak to peak voltage
DC Voltage at RF Input	V				±12	AC coupled input
DC Voltage at RF Output	V				-5... +12	AC coupled output
Positive Supply Voltage	V		7.5	8	9.2	typ. 0.3 A, max. 0.35 A ² reverse voltage protected
Gain Control Voltage	V		-6	-5...0	+6	will not exceed 0.02 A
Crossing Control Voltage	V		-6	-5...+5	+6	will not exceed 0.02 A
Case Temperature	T _{case}	°C	10	45	55	



Parameter	Unit	Symbol	Min	Typ	Max	Conditions
Electrical Characteristics (At 45°C case temperature, unless otherwise specified)						
High Frequency 3 dB Point	GHz	f _{HIGH}	34	38		
Low Frequency 3 dB Point	kHz	f _{LOW}			95	
Gain	dB	S ₂₁	14	15		inverting measured at P _{in} =-27 dBm @ 500 MHz
Output Power at 1 dB Compression	dBm V	P _{01dB}	16 4.0			10 MHz...20 GHz peak to peak voltage
Output Power at 2 dB Compression	dBm V	P _{02dB}	19 5.6			10 MHz...20 GHz peak to peak voltage
Output Power at 3 dB Compression	dBm V	P _{03dB}	20.5 6.7			10 MHz...20 GHz peak to peak voltage
Input Return Loss	dB	S ₁₁			-10 -8	< 20 GHz < 34 GHz
Output Return Loss	dB	S ₂₂			-10 -8	< 20 GHz < 34 GHz
Rise Time/Fall Time	ps	t _r /t _f			11 15	20%...80% Deconvoluted ^{2,3} Full Setup ²
Jitter	fs	J _{RMS}		500 550	600 650	Deconvoluted ^{2,3} Full Setup ²
Group Delay Ripple	ps				±50	500 MHz...30 GHz, 160 MHz aperture
Power Consumption	W			2.4		V _{DD} = 8 V / I _{DD} = 0.3A
Mechanical Characteristics						
Input Connector						2.9mm (K) female ⁴
Output Connector						2.9mm (K) male ⁴

² Measured with SHF 611C DAC (at full scale) -> DUT (SHF M834 A) -> Agilent 86100C with 70 GHz sampling head & precision time base.

³ Calculation based on typical results of setup without DUT :

$$t_{r \text{ deconvoluted}} = \sqrt{(t_{r \text{ full setup}})^2 - (t_{r \text{ setup w/o DUT}})^2} = \sqrt{(t_{r \text{ full setup}})^2 - (11 \text{ ps})^2}$$

$$J_{RMS \text{ deconvoluted}} = \sqrt{(J_{RMS \text{ full setup}})^2 - (J_{RMS \text{ setup w/o DUT}})^2} = \sqrt{(J_{RMS \text{ full setup}})^2 - (300 \text{ fs})^2}$$

⁴ Other gender configurations are available on request.



Typical S-Parameters, Group Delay and Phase Response

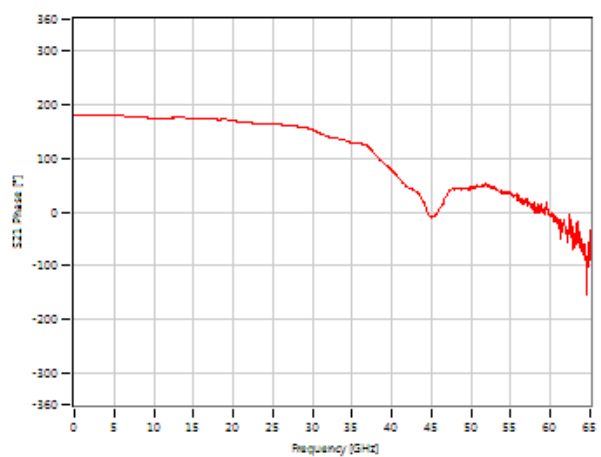
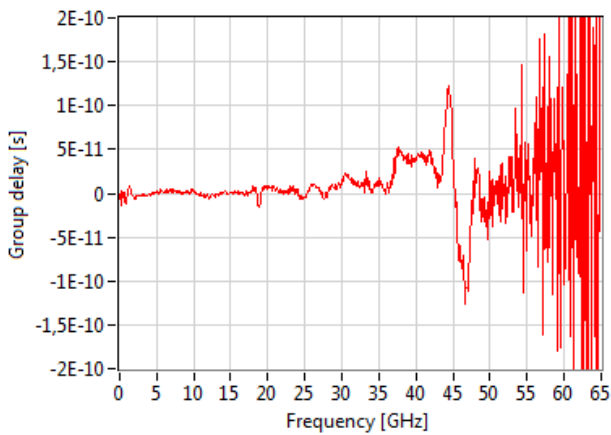
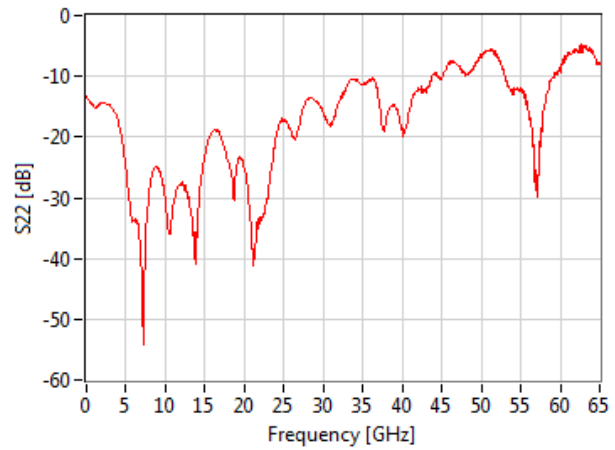
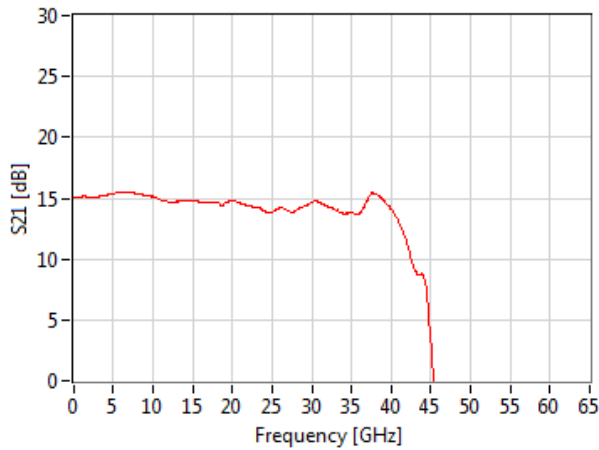
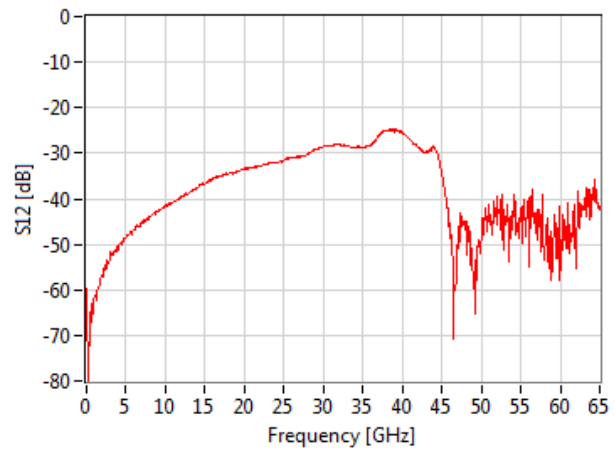
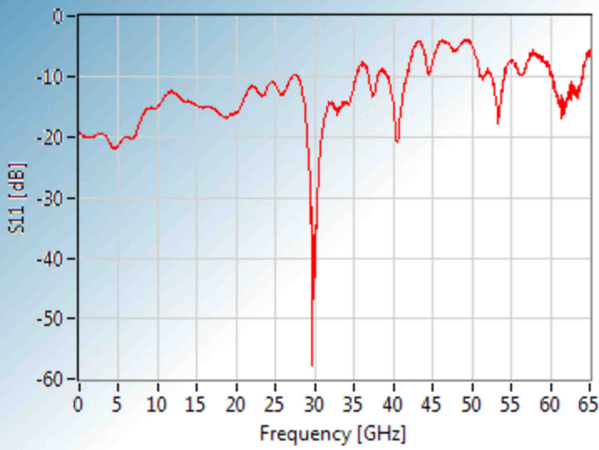

Aperture of group delay measurement: 160 MHz



Typical Binary Eye Diagrams

Measurements for ~3 V had been performed using a SHF611 C DAC in binary mode and an Agilent 86100C DCA with Precision Time Base Module (86107A) and 70 GHz Sampling Head (86118A).

Input signals for higher amplitude had been taken from SHF 12103 A BPG with preamplifier M827 A. These will not be part of the inspection report delivered with each particular device.

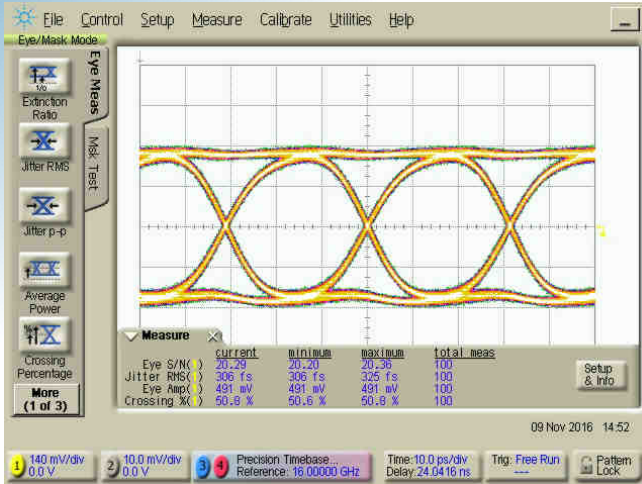

Input Signal @ 32 Gbps, Eye amp: 491 mV

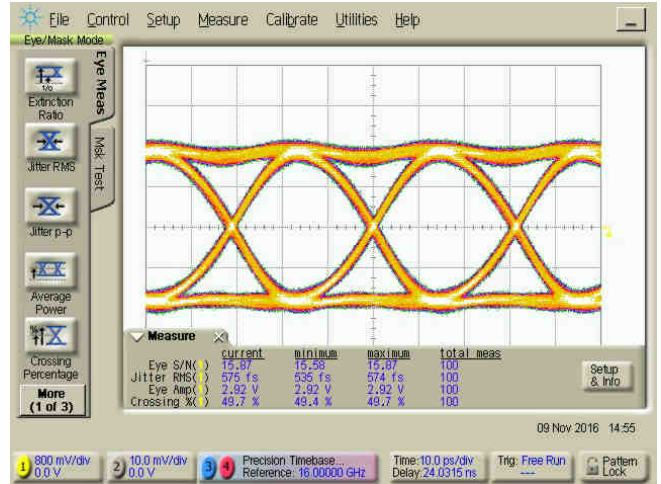

Output Signal @ 32 Gbps, Eye amp: 2.9 V

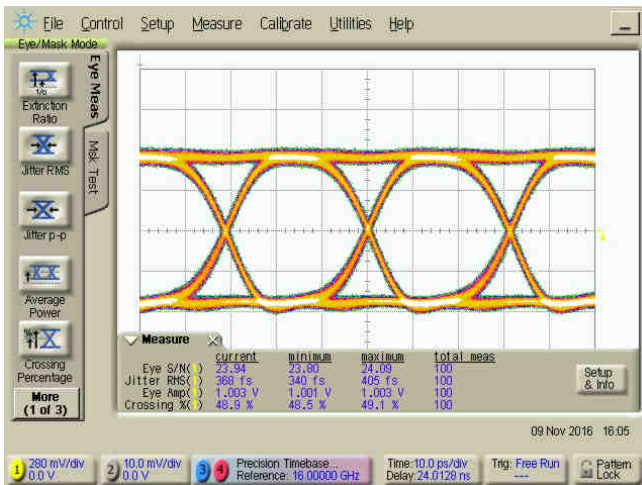

Input Signal @ 32 Gbps, Eye amp: 1 V

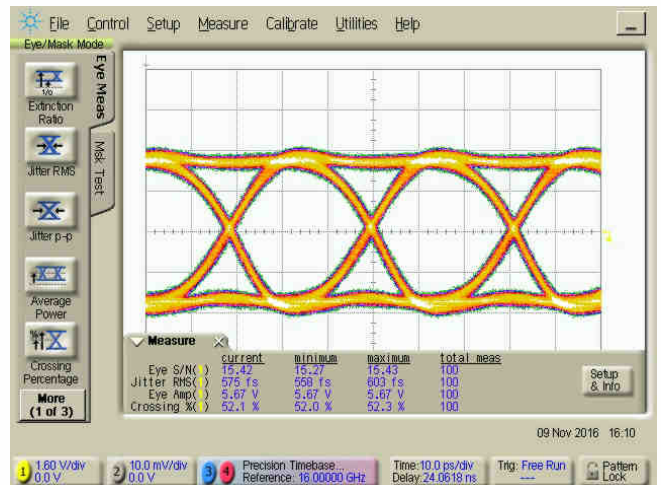

Output Signal @ 32 Gbps, Eye amp: 5.7 V

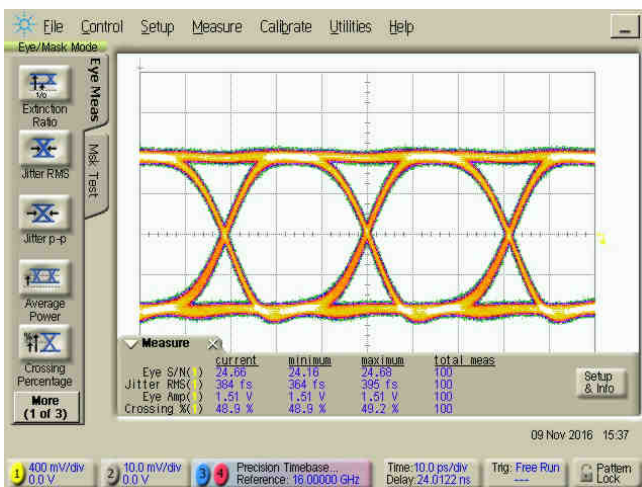

Input Signal @ 32 Gbps, Eye amp: 1.5 V

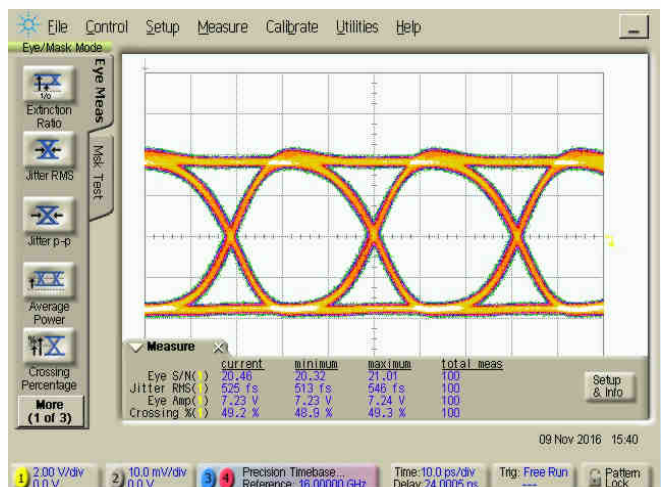

Output Signal @ 32 Gbps, Eye amp: 7.2 V



Typical 4-Level Eye Diagrams

All measurements had been performed using a SHF 611C DAC and an Agilent 86100C DCA with Precision Time Base Module (86107A) and 70 GHz Sampling Head (86118A).

Measurements for ~3V Amplitude will be part of the inspection report delivered with each particular device.

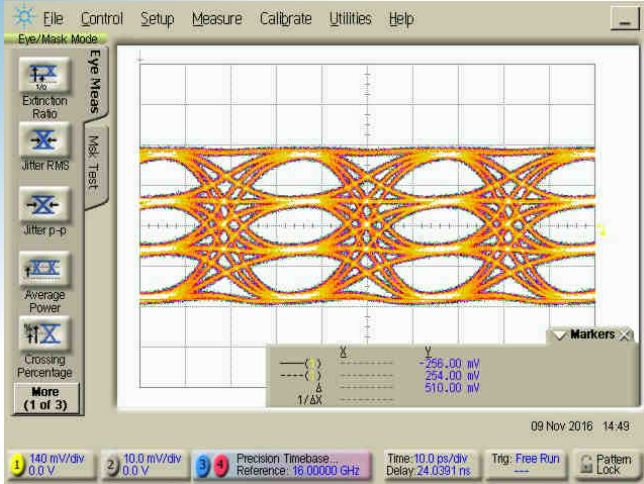

Input Signal @ 32 GBaud, ~510 mV

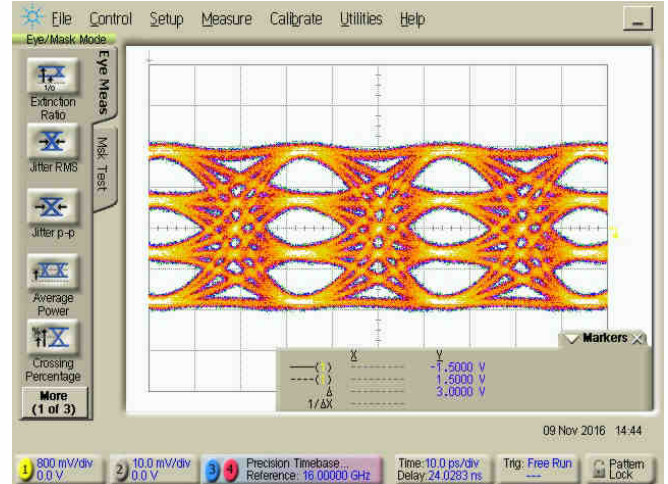

Output Signal @ 32 GBaud, ~3 V

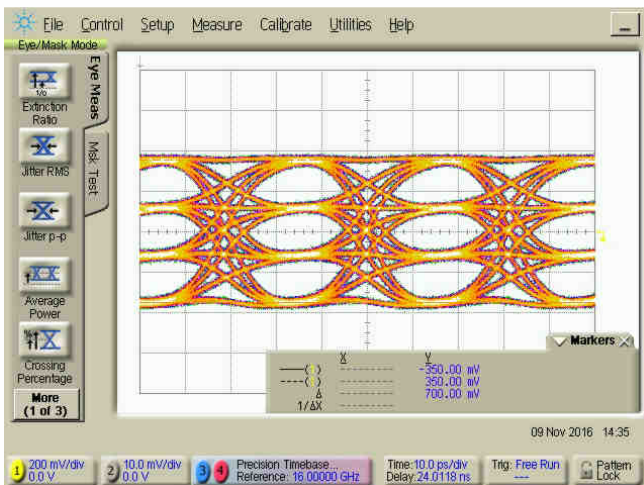

Input Signal @ 32 GBaud, ~700 mVpp

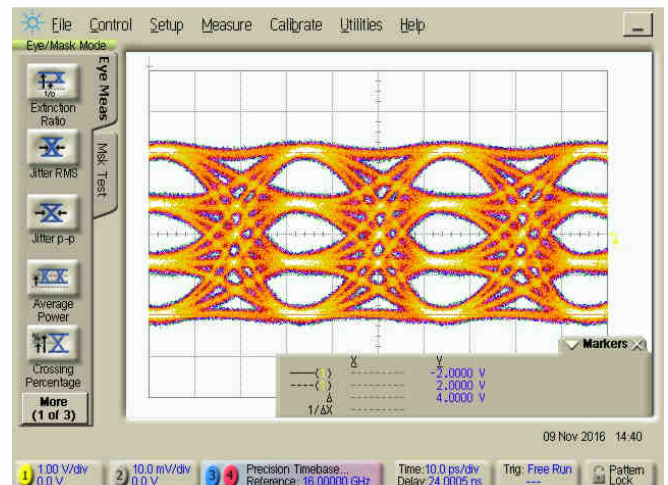

Output Signal @ 32 GBaud, ~4.0 Vpp



Handling Instructions

To operate the amplifier a positive supply voltage of approximately +8 V must be applied.

The gain can be adjusted by applying a voltage of 0 to -5 V. If this pin is left open, the amplifier will have maximum gain. By reducing the gain the crossing will shift. Typical characteristics are shown in the following diagram for an input voltage of 1 V with 50% crossing.

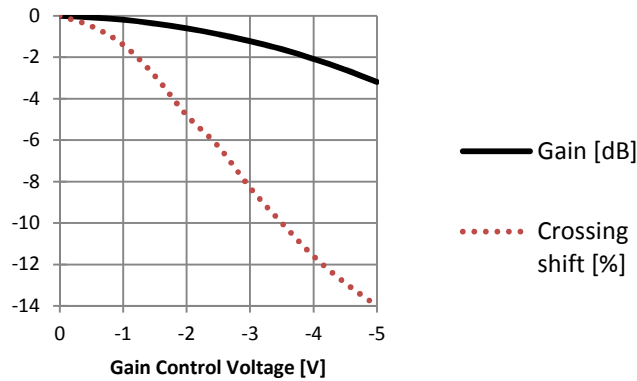

The crossing can be adjusted by applying a voltage of -5 to +5 V. If this pin is left open a crossing of approximately 50 % is achieved. The range depends on the input voltage. Typical characteristics are shown in the following diagram for input voltages of 0.5, 1.0 and 1.5 V with 50% crossing.

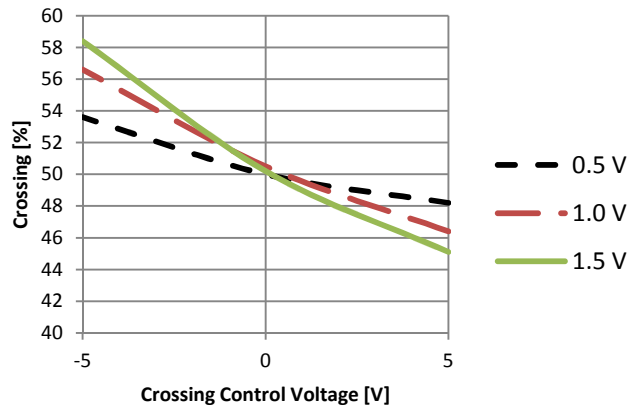

Note: If both functions are used the effect of the gain control will decrease up to -1 dB. This is the typical characteristic of a single stage amplifier.



Typical Low Frequency Response (<1 MHz)

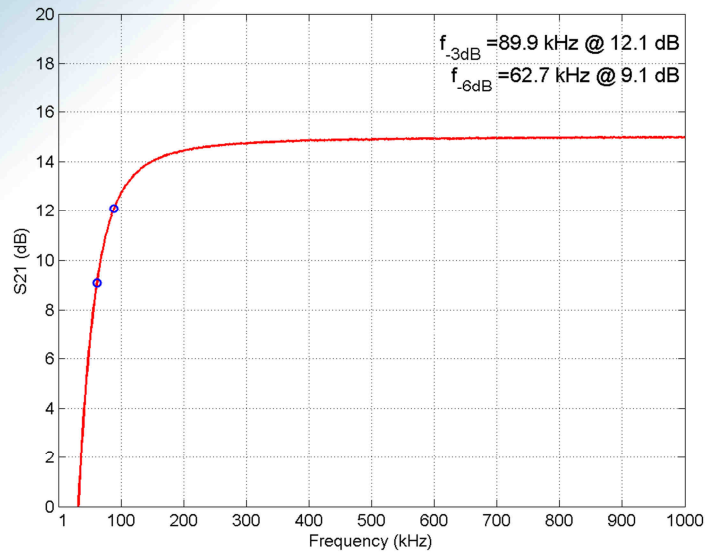

Typical Saturation power

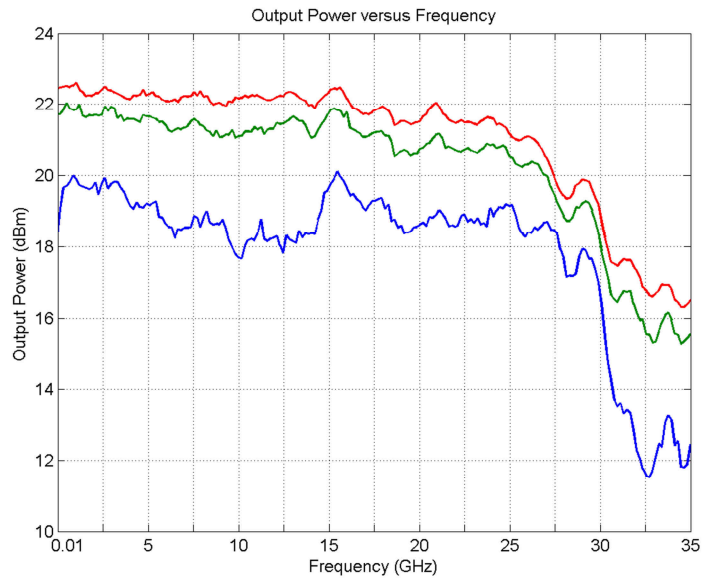

Top (red): 3 dB compression;
Middle (green): 2 dB compression;
Bottom (blue): 1 dB compression



Mechanical Drawing with Heat Sink

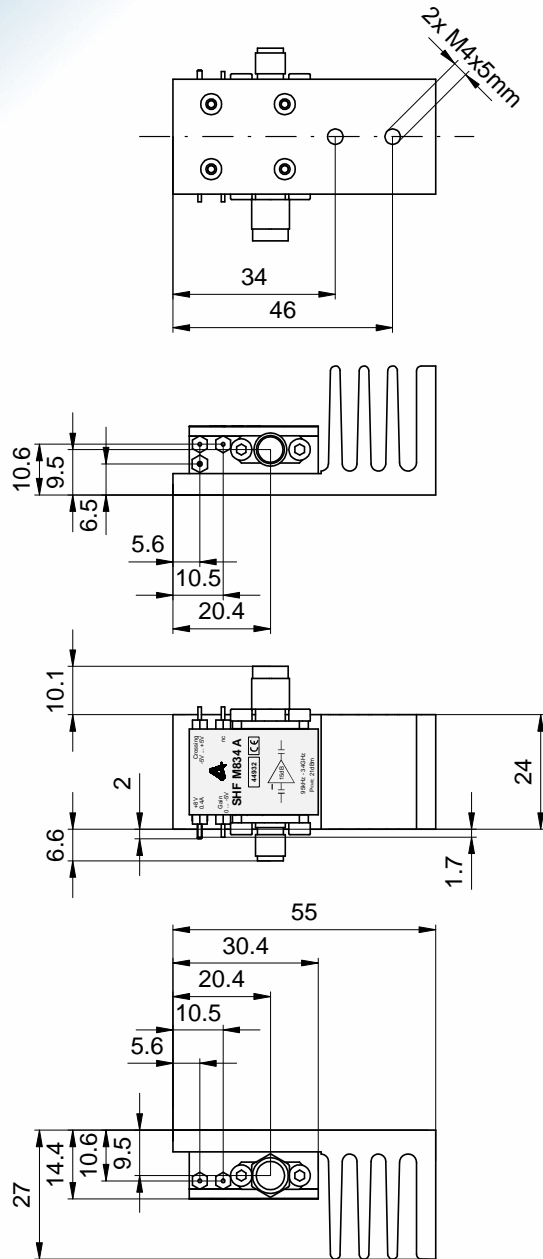

All dimensions in mm

Pin assignment might change if a bias tee option is chosen.

For permanent mounting remove the heat sink from the amplifier. In that case please ensure that adequate cooling of the amplifier is guaranteed. It is recommended to use thermal paste or a thermal gap pad for the mounting. In order to separate the heat sink from the amplifier, remove the four screws on the heat sink. Please note, thermal paste is used between the heat sink and the amplifier housing.



Mechanical Drawing without Heat Sink

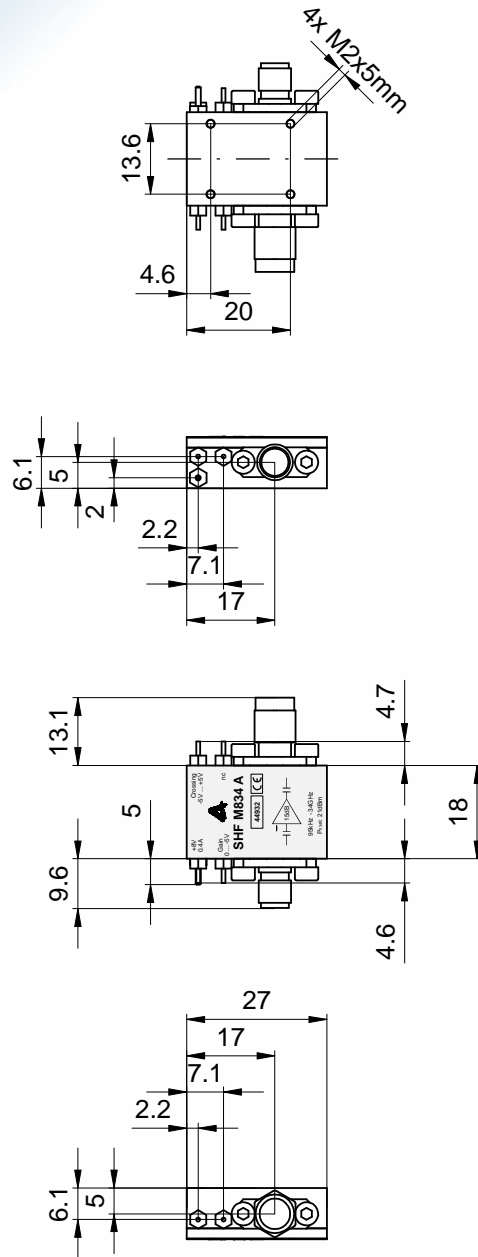

All dimensions in mm

Pin assignment might change if a bias tee option is chosen.

Please ensure that adequate cooling of the amplifier is guaranteed.



User Instructions

ATTENTION!

Electrostatic sensitive GaAs FET amplifier

1. To prevent damage through static charge build up, cables should be always discharged before connecting them to the amplifier!
2. Attach a 50 Ohm output load **before** supplying DC power to the amplifier!
3. The supply voltage can be taken from any regular 7.5...9.2 V, 0.4 A DC power supply and can be connected to the supply feed-through filter via an ON / OFF switch.
4. Using a 3 dB or 6 dB input attenuator will result in a 6 dB or 12 dB increase of the input return loss. For minimal degradation of amplifier rise time, these attenuators should have a bandwidth specification of greater 50 GHz (V/ 1.85mm attenuators)!
5. An input signal of about 1.8 V_{pp} will produce saturated output swing of about 7 V_{pp}.
6. Higher input voltages will drive the amplifier's output stage into saturation, leading to waveform peak clipping.
8. Saturated output voltages can only be used without damage while the amplifier is connected to a 50 Ohm precision load with a VSWR of less than 1.2 or better than 20 dB return loss up to 40 GHz.
9. While using a reflective load the output voltage has to be reduced to a safe operating level according to the magnitudes of the reflections.

ATTENTION: At radio frequencies a capacitive load can be transformed to an inductive one through transmission lines! With an output stage driven into saturation this may lead to the immediate destruction of the amplifier (within a few ps)!

10. The input voltage should never be greater than 2 V_{pp} equivalent to 10 dBm input power.

The input voltage without DC power supplied to the amplifier should never be greater than 2 V_{pp} equivalent to 10 dBm input power.