

Data Sheet

SHF C911 A



32 / 67 GBaud 4-Bit DAC



Description

The SHF C911 A is a 4-Bit Digital-to-Analog Converter (DAC) operating at symbol rates either up to 32 or 67 GBaud for use in broadband test setups and telecom transmission systems. Four single ended serial data streams of up to 32 or 67 Gbps are accepted by the DAC and converted into one differential 16-level data signal of up to 32 or 67 GBaud. By using two input ports only it is possible to generate 4-level output signals. A single ended clock signal with the same frequency as the data rate drives the SHF C911 A. Thus the baud rate of the resulting PAM signal is as fast as the sample rate of the system.

For data regeneration purposes all input data signals are re-sampled to mitigate any signal impairments resulting e.g. from long cables. Therefore, it becomes possible to place the DAC very close to the DUT. Clock input port and data output ports are AC-coupled. Data input ports are DC-coupled.

Features

- Broadband operation up to 32 or 67 GBaud
- Output baud rate = sample rate
- Differential data output, 570 mV single ended output swing
- Single ended clock and data inputs
- Latched input ports
- Output level control
- Controlled by intuitive graphical user interface SHF Control Center (SCC) via USB

Applications

- 100G, 200G and 400G system evaluation & development
- OC-768 / STM-256 applications
- Telecom transmission
- Fibre Channel®
- Broadband test and measurement equipment

Configurations

- 32: Operation up to 32 GBaud
- 67: Operation up to 67 GBaud

° Fibre Channel is a registered trademark of the Fibre Channel Industry Association

Accessories

- +12 V Power Supply Desktop Adapter
- Mini-USB cable
- Functional earth cable → Connection to test setup ground has to be set up first before any other connection to prevent instrument damage!

Block Diagram

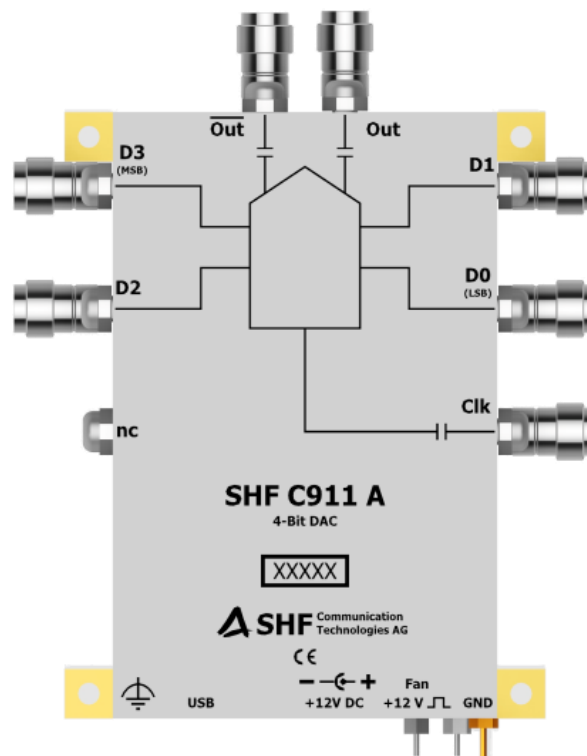

Ease of Use

The SHF C911 A DAC module including the power supply and the cooling measures can easily be embedded in the customer's test environment. It is to be connected to a computer by USB. At delivery the DAC module is mounted and connected to an active heat sink. The heat sink fans are regulated and powered by the DAC module. The DAC may also be used without the delivered heat-sink in case other adequate cooling measures are provided.



Fig. 2: SHF C911 A

The DAC is controlled by the easy to use SHF Control Center (SCC) software package. The software reads the individual calibration tables of the DAC and sets the contribution of the bias voltages accordingly. The amplitude of the individual eye openings as well as the input threshold level for the DC-coupled data inputs can be set and is displayed in the graphical user interface (GUI). This enables the user to generate a perfect signal with a few intuitive clicks.

This SCC software interface does further support the user in case the SHF C911 A DAC is connected to another SHF instrument. For example, if the DAC is connected to a SHF 12105 A Bit Pattern Generator (BPG) the software unifies the two discrete instruments to one single multi-level source. The user can program the signal desired at the DACs output; the SCC automatically translates the desired output multi-level pattern to the four individual binary patterns which are stored in the BPGs user pattern memory and sent to the DACs inputs.

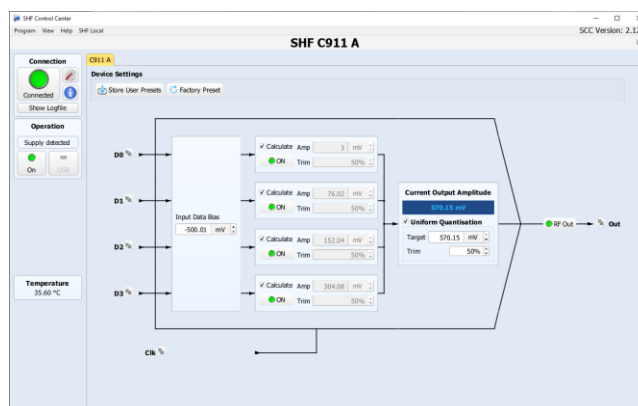

Fig. 3: SHF Control Center – GUI for the SHF C911 A



Specifications

Absolute Maximum Ratings

Parameter	Unit	Symbol	Min	Typ	Max	Comment
Data Input Voltage	mV	$V_{data\ in}$			950	Peak-to-Peak
Clock Input Voltage	mV	$V_{clk\ in}$			950	Peak-to-Peak
External DC Voltage on RF Clock Input Port & Data Output Ports	V	V_{DCin}	-10		+10	AC coupled ports
External DC Voltage on RF Data Input Ports	V	V_{DCin}	-0.6		+0.1	DC coupled inputs
DC Supply Voltage	V	V_{cc}			14	

Input Parameters

Parameter	Unit	Symbol	Min	Typ	Max	Comment
Min. Input Data Rate	Gbps	$R_{in,min}$			5	
Max. Input Data Rate	Gbps	$R_{in,max}$	67 ¹ 32 ¹			Configuration 67 Configuration 32
Data Input Voltage	mV	$V_{data\ in}$	200		850	Eye amplitude
External DC Voltage on RF Data Input Ports	V	V_{DCin}	-0.5		0	DC coupled inputs
Min. Clock Input Frequency	GHz	$f_{in,min}$			5	
Max. Clock Input Frequency	GHz	$f_{in,max}$	67 32			Configuration 67 Configuration 32
Clock Input Voltage	mV	$V_{clk\ in}$	200		900	Peak-to-Peak
External DC Voltage on RF Clock Input Port	V	V_{DCin}	-9		+9	AC coupled input

¹ The upper baud rate limit is defined by the absence of errors (BER < 10⁻¹²) of a NRZ output. The DAC operates beyond this limit as shown in the typical eye diagrams below.



Output Parameters

Parameter	Unit	Symbol	Min	Typ	Max	Comment
Min. Output Data Rate	GBaud	$R_{out,min}$			5	
Max. Output Data Rate	GBaud	$R_{out,max}$	67^2 32^2			Configuration 67 Configuration 32
Output Voltage	mV	V_{out}	520			Eye amplitude; Single ended; AC coupled; Full scale; Adjustable up to -6 dB
Rise / Fall Time	ps	t_r / t_f			6.8 8.2	Configuration 67 Configuration 32 20%...80%; Full scale; deconvolved ³
Equivalent Output Bandwidth	GHz	BW	32 27			Configuration 67 Configuration 32 Derived from Rise Time using formula ⁴ ; -3 dB bandwidth
Differential Output Skew	ps	t_{skew}		1	2	

Power Requirements

Parameter	Unit	Symbol	Min	Typ	Max	Comment
Supply Voltage	V	V_{cc}	+11.5	+12.0	+12.5	
Supply Current	A	I_{cc}		0.86 0.96		Without heat sink With heat sink
Power Dissipation	W	P_d		10.3 11.5		Without heat sink With heat sink @ $V_{cc} = +12$ V

² The upper baud rate limit is defined by the absence of errors ($BER < 10^{-12}$) of a NRZ output.

³ Calculation based on typical rise / fall times from oscilloscope data sheet and with a NRZ output generated by bit synchronization of the MSB + LSB

$t_{r\ deconvolved} = \sqrt{(t_{r\ measured})^2 - (t_{r\ oscilloscope})^2} = \sqrt{(t_{r\ meas.})^2 - (3.68\ ps)^2}$

⁴ Calculation based on formula: $BW = \frac{0,22}{T_r}$

Integrated Fan Control⁵

Parameter	Unit	Symbol	Min	Typ	Max	Comment
Output Voltage Fan	V	$V_{Fan+12V}$		+12		30 Hz – PWM-Signal
Output Current Fan	A	$I_{Fan+12V}$		0.13		
Input Tacho Fan	V	$V_{Fan Tacho}$		3.3		

Mechanical Characteristics

Parameter	Unit	Symbol	Min	Typ	Max	Comment
Clock In	Ω			50		Configuration 67: 1.85 mm (V) female Configuration 32: 2.92 mm (K) female
Data In	Ω			50		Configuration 67: 1.85 mm (V) female Configuration 32: 2.92 mm (K) female
Data Out	Ω			50		Configuration 67: 1.85 mm (V) female Configuration 32: 2.92 mm (K) female
Dimensions	mm					See Outline Drawing on pages 20 - 23
Weight	g			190 480		Without heat sink With heat sink

Conditions

Parameter	Unit	Symbol	Min	Typ	Max	Comment
Operating Temperature	°C	$T_{ambient}$	15		35	

⁵ It is necessary to operate the module with the supplied heat sink and fan or an adequate cooling measure



Output Amplitudes

Below mentioned values assume no attenuation to be set in the control software. The output amplitude of the DAC can be reduced by 0 to -6 dB by making the appropriate setting in the control software.

Output Amplitude					
Input D3 (MSB)	Input D2	Input D1	Input D0 (LSB)	Minimum Output Amplitude [mV]	Maximum Output Amplitude [mV]
-	-	-	On	30	45
-	-	On	-	70	90
-	On	-	-	140	180
On	-	-	-	280	360

The output amplitude of a multilevel signal can be calculated by accumulating the output amplitudes of all applied input ports of the DAC as shown in the table above. Thus the full scale output swing (all inputs active) accumulates as follows:

On	On	On	On	520	675
----	----	----	----	------------	------------



Typical Output Waveforms – Configuration 67

The measurements below had been performed using a SHF 12105 A Bit Pattern Generator (PRBS $2^{31}-1$) and a Tektronix DSA 8300 Digital Serial Analyzer (DSA) with Phase Reference Module (82A04B-60G) and 70 GHz Sampling Module (80E11). The outputs of the DAC module had been connected directly to the DSA input with a 10 dB attenuator. In all measurements the most significant bits have been used, i.e. 4-Level = D3,D2, 8-Level = D3,D2,D1 and 16-Level = D3,D2,D1,D0.

4-Level Output Signal Measurement

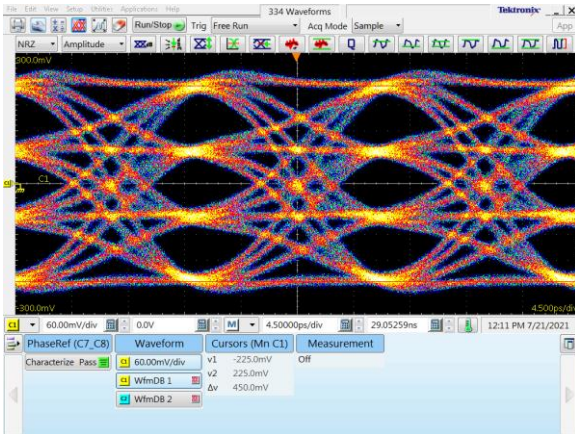

Out @ 67 GBaud

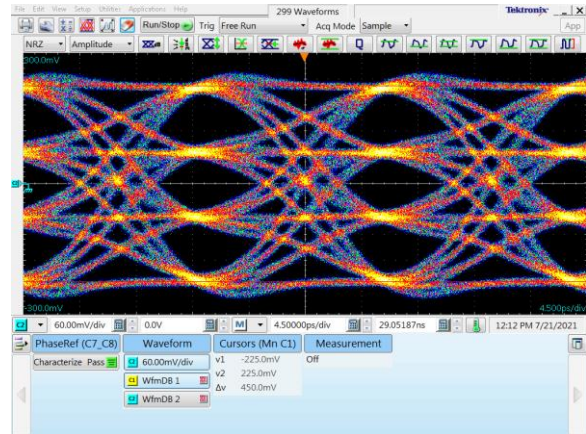

Out! @ 67 GBaud

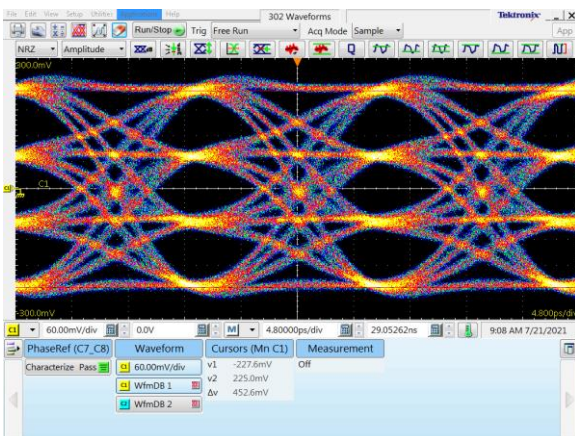

Out @ 64 GBaud

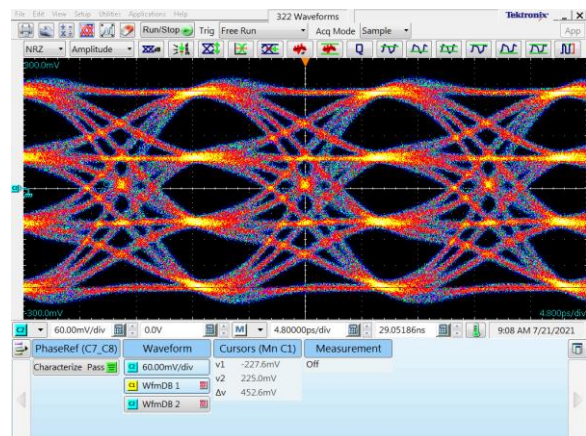

Out! @ 64 GBaud

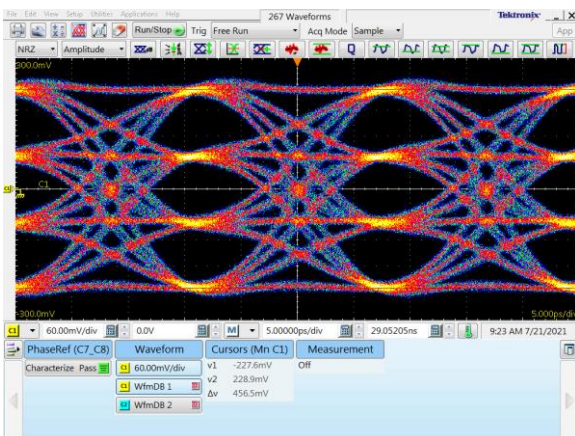

Out @ 60 GBaud

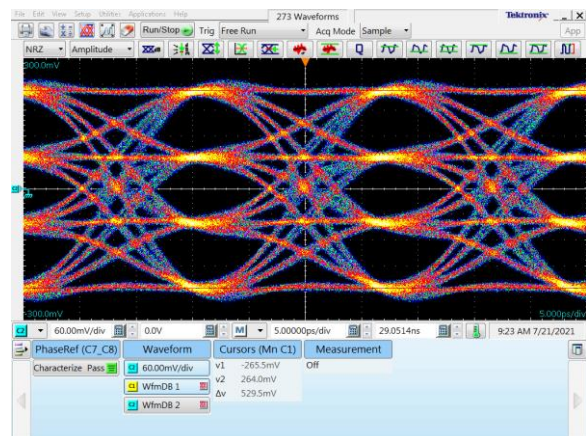

Out! @ 60 GBaud



4-Level Output Signal Measurement

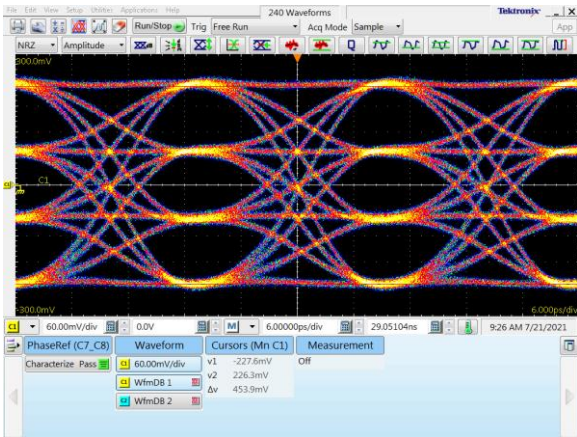

Out @ 50 GBaud

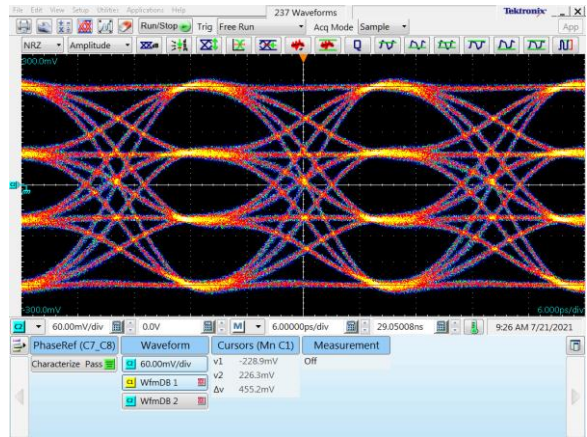

Out! @ 50 GBaud

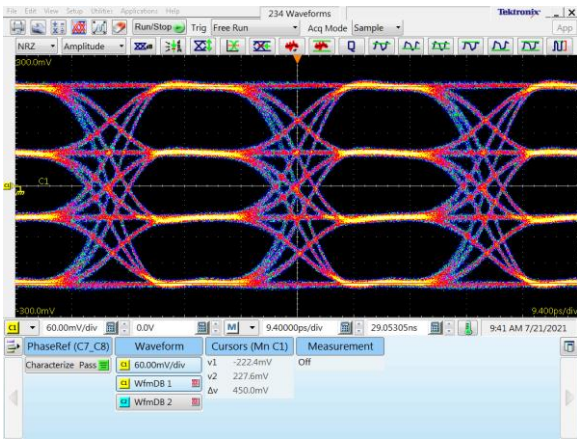

Out @ 32 GBaud

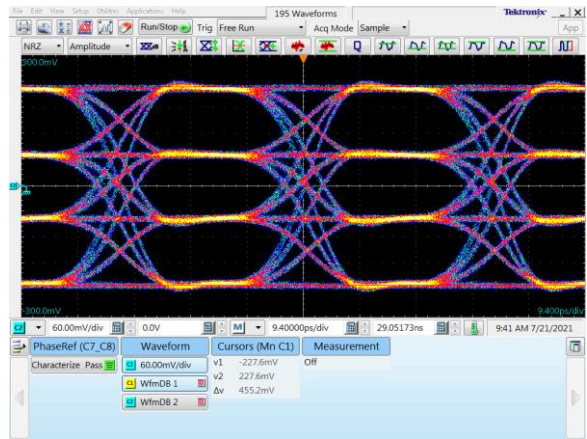

Out! @ 32 GBaud

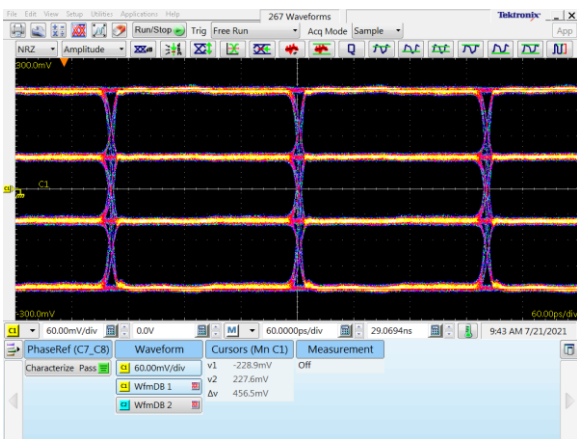

Out @ 5 GBaud

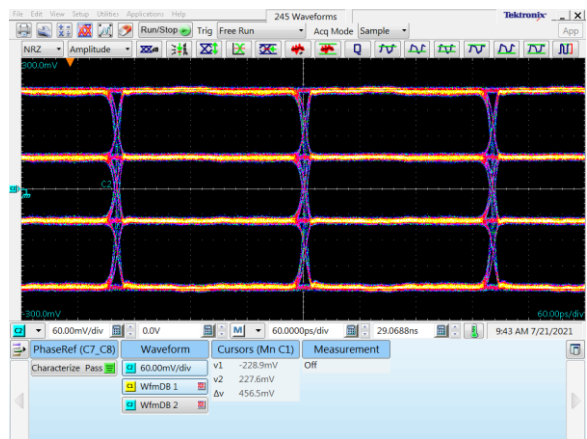

Out! @ 5 GBaud



8-Level Output Signal Measurement

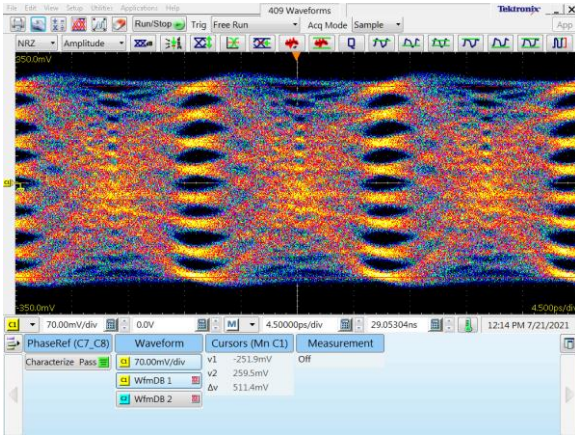

Out @ 67 GBaud

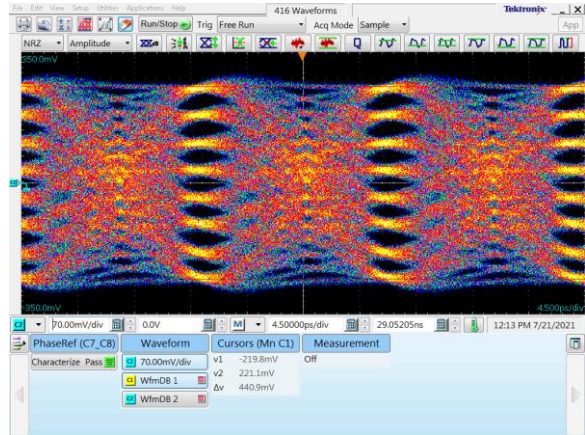

Out! @ 67 GBaud

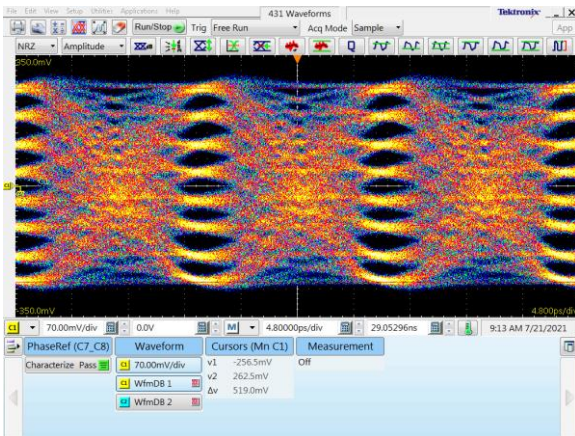

Out @ 64 GBaud

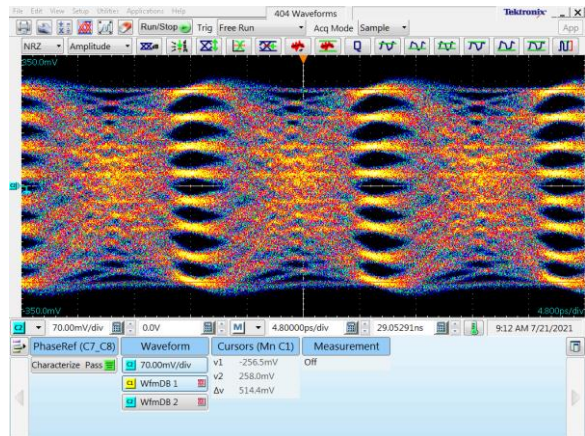

Out! @ 64 GBaud

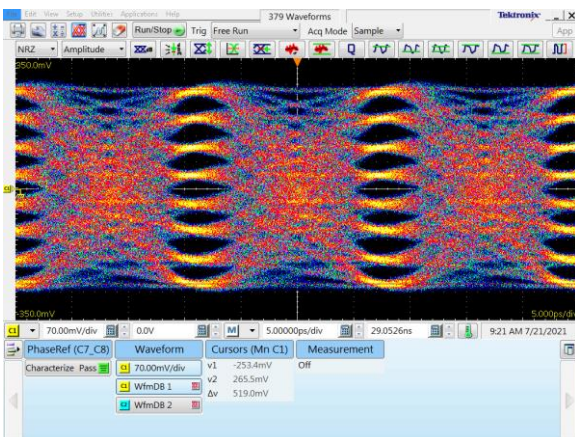

Out @ 60 GBaud

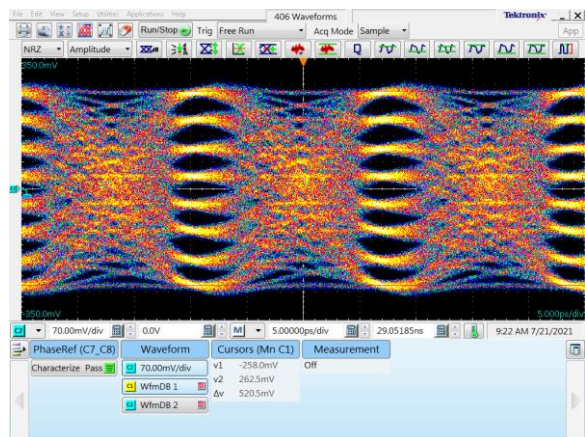

Out! @ 60 GBaud



8-Level Output Signal Measurement

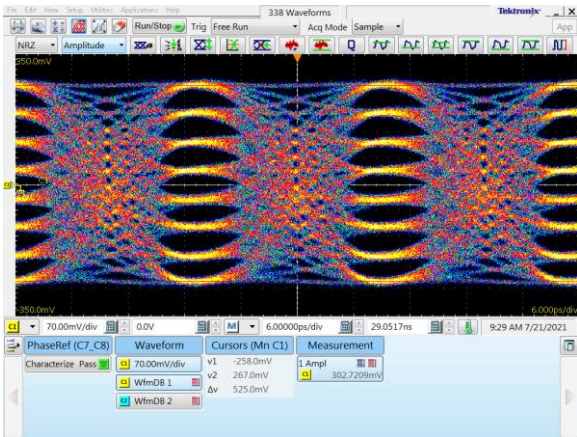

Out @ 50 GBaud

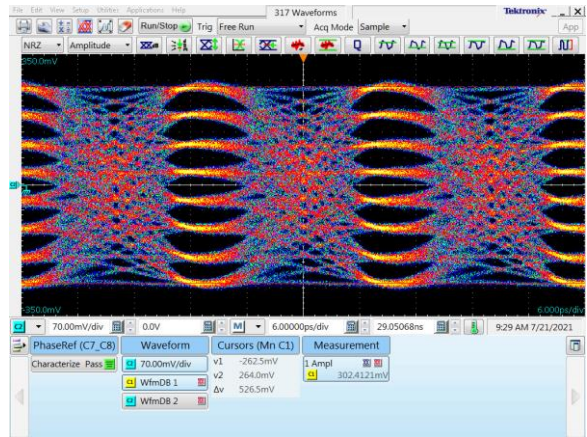

Out! @ 50 GBaud

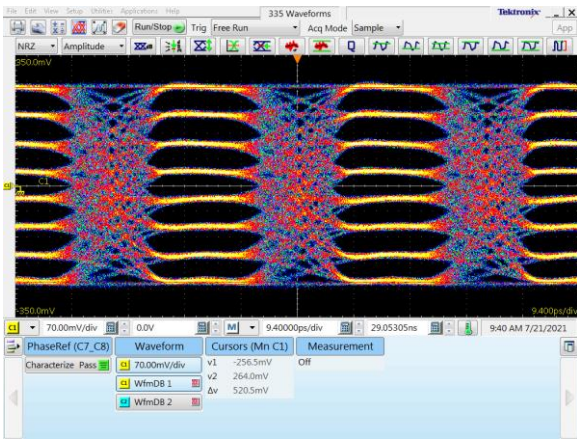

Out @ 32 GBaud

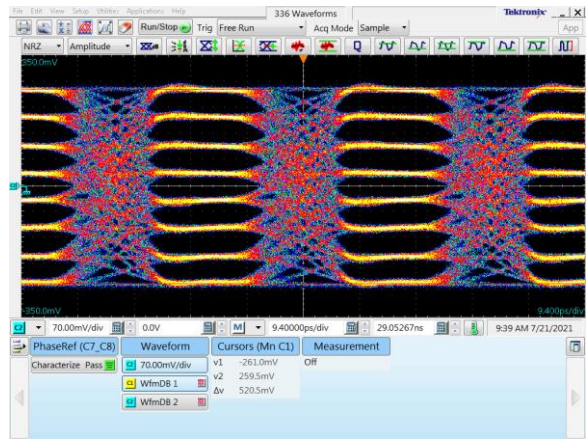

Out! @ 32 GBaud

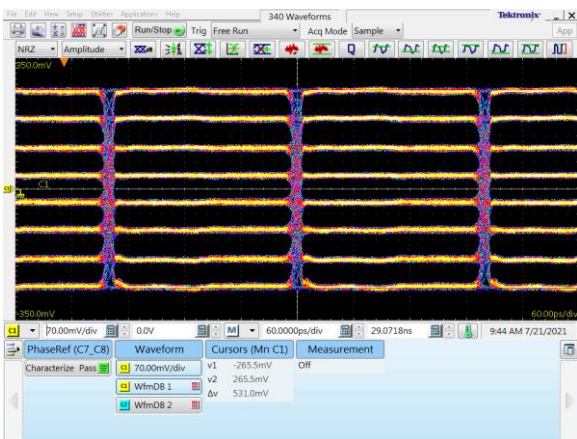

Out @ 5 GBaud

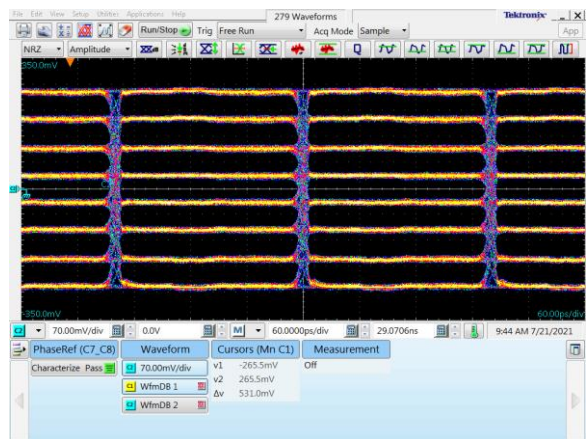

Out! @ 5 GBaud



16-Level Output Signal Measurement

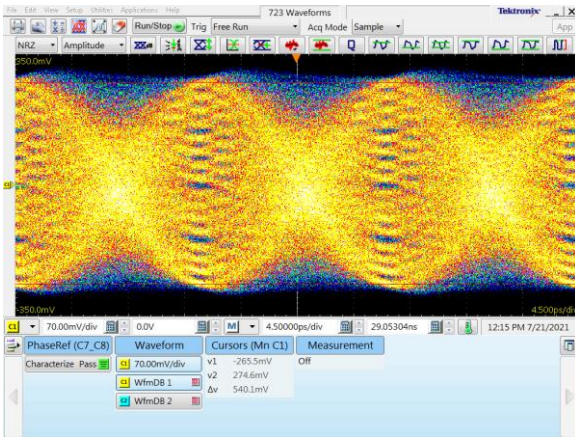

Out @ 67 GBaud

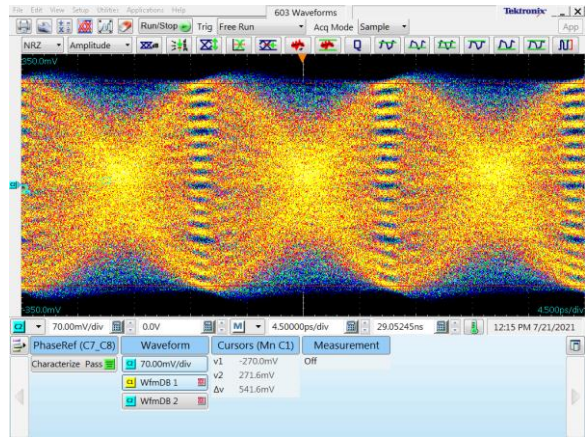

Out! @ 67 GBaud

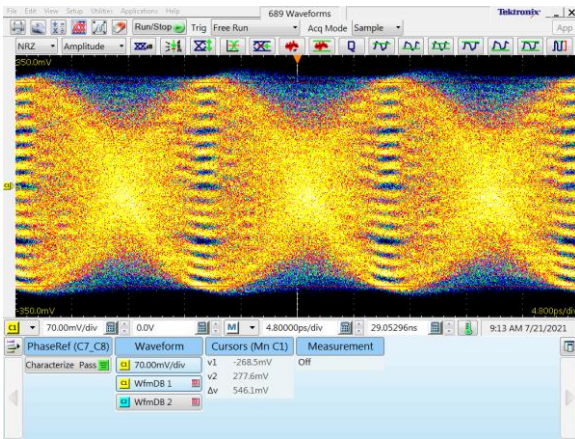

Out @ 64 GBaud

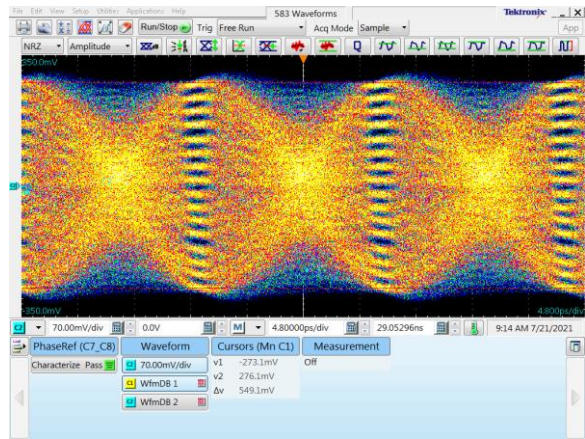

Out! @ 64 GBaud

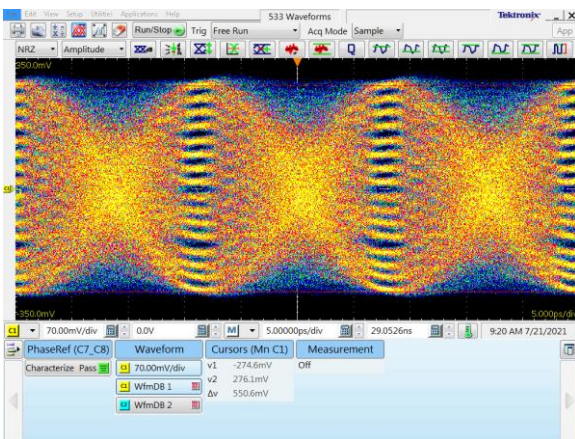

Out @ 60 GBaud

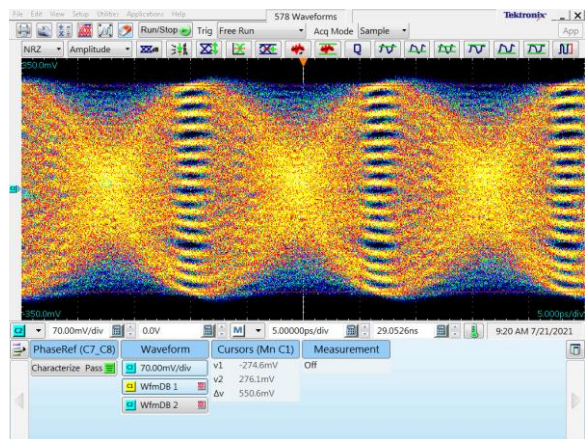

Out! @ 60 GBaud



16-Level Output Signal Measurement

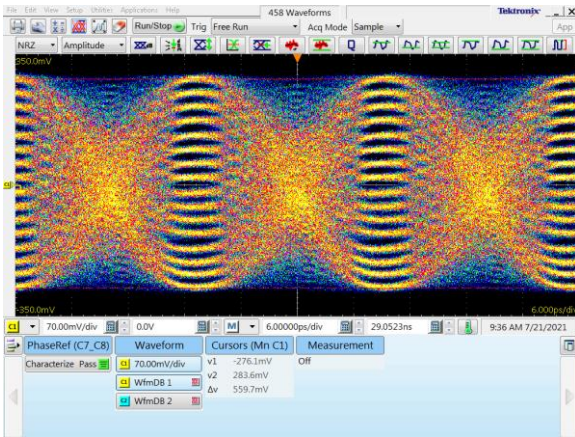

Out @ 50 GBaud

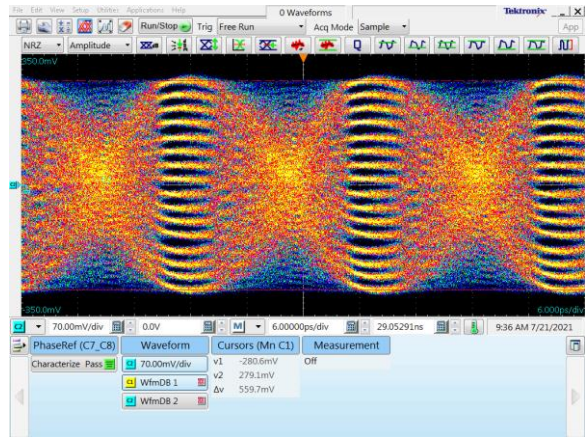

Out! @ 50 GBaud

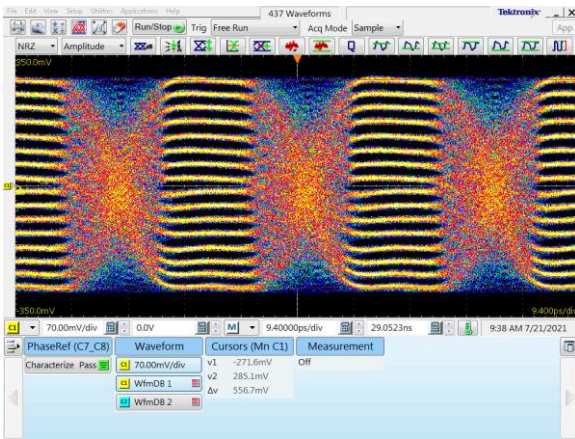

Out @ 32 GBaud

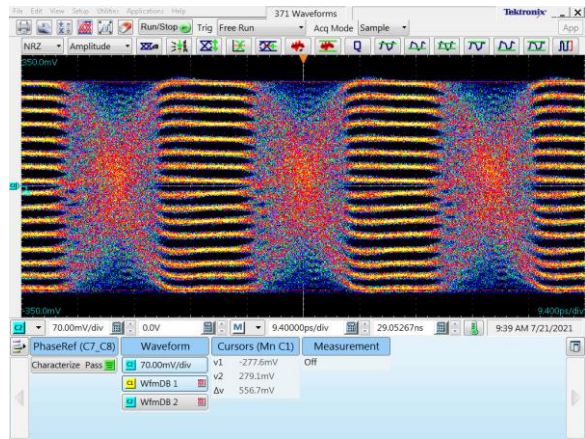

Out! @ 32 GBaud

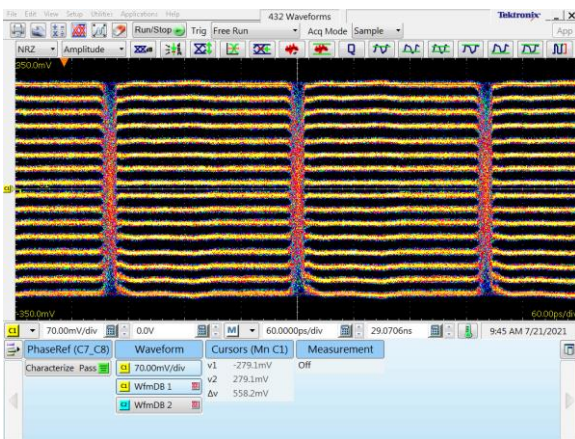

Out @ 5 GBaud

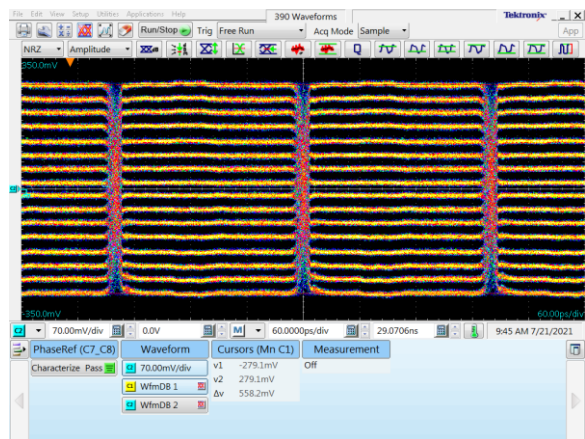

Out! @ 5 GBaud



Output Amplitude Adjustment

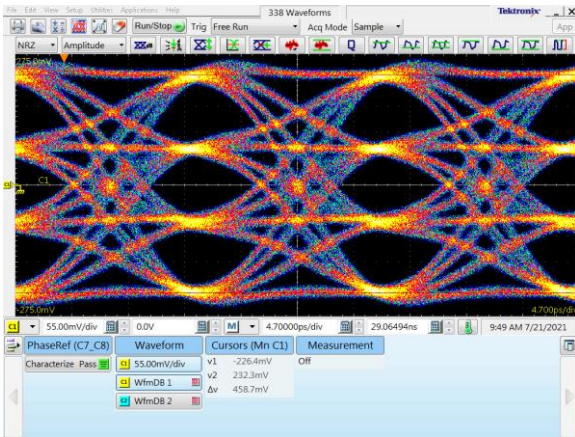

64 GBaud @ 460 mV

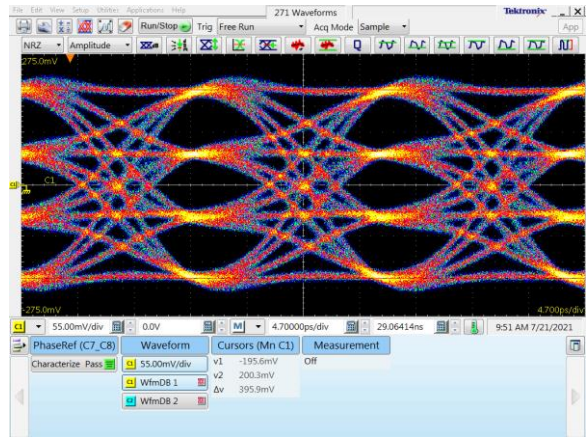

64 GBaud @ 400 mV

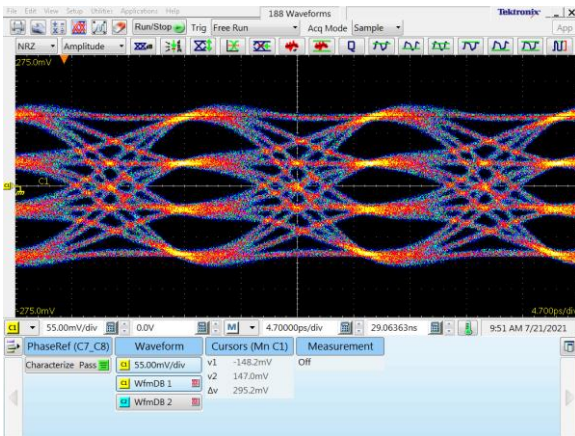

64 GBaud @ 300 mV

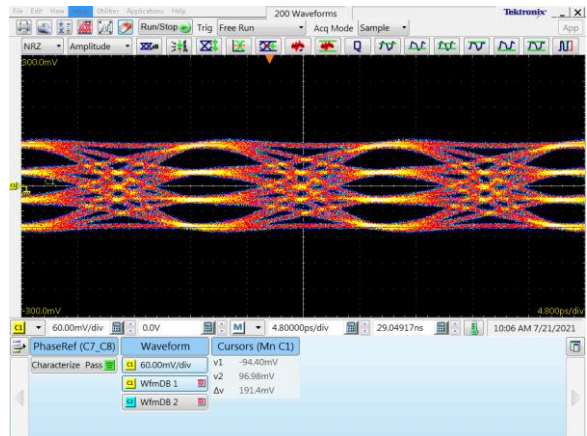

64 GBaud @ 200 mV

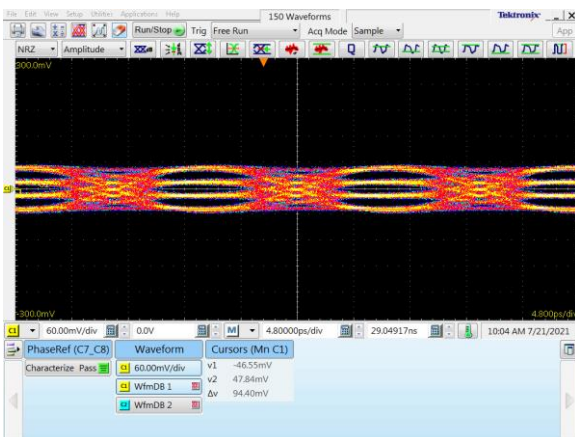

64 GBaud @ 100 mV



Output Signal Speed (Trim) - Adjustment

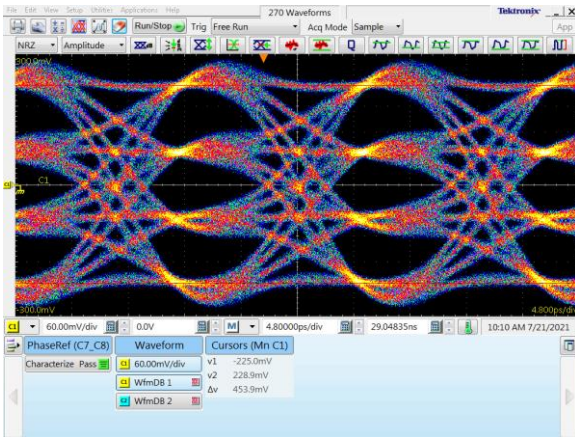

64 GBaud @ TRIM = 100 %

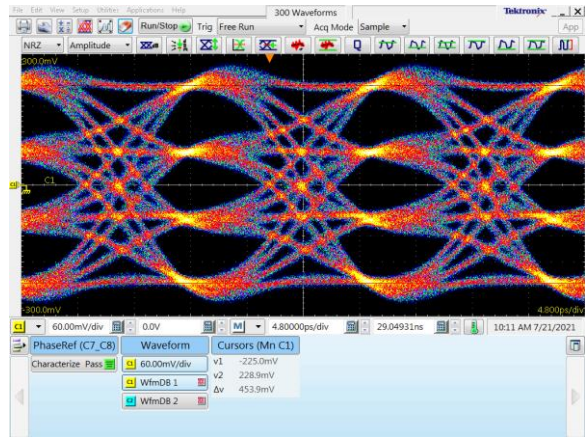

64 GBaud @ TRIM = 80 %

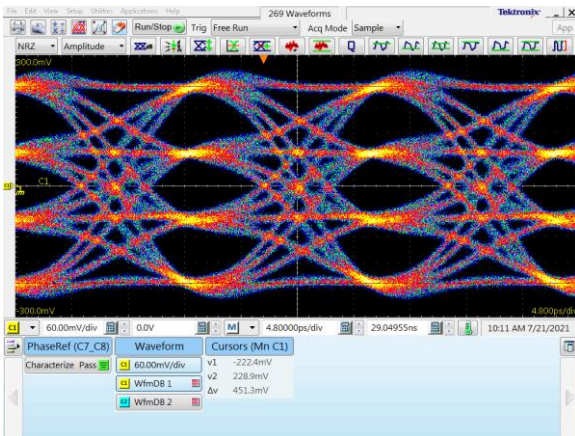

64 GBaud @ TRIM = 60 %

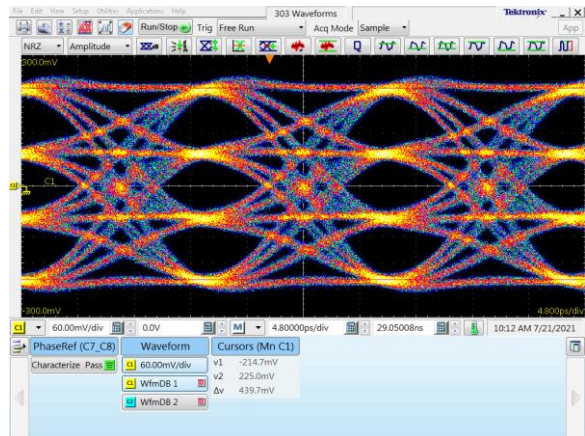

64 GBaud @ TRIM = 40 %

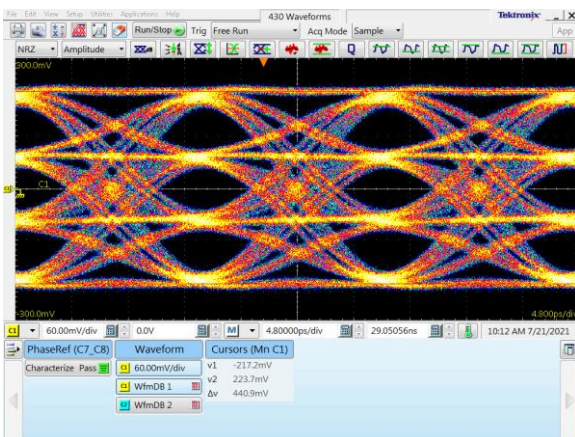

64 GBaud @ TRIM = 20 %

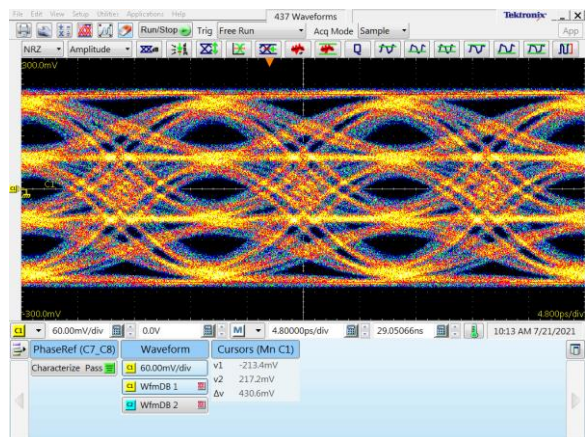

64 GBaud @ TRIM = 0 %



Typical Output Waveforms – Configuration 32

The measurements below had been performed using a SHF 12105 A Bit Pattern Generator (PRBS $2^{31}-1$) and a Tektronix DSA 8300 Digital Serial Analyzer (DSA) with Phase Reference Module (82A04B-60G) and 70 GHz Sampling Module (80E11). The outputs of the DAC module had been connected directly to the DSA input with a 10 dB attenuator. In all measurements the most significant bits have been used, i.e. 4-Level = D3,D2, 8-Level = D3,D2,D1 and 16-Level = D3,D2,D1,D0.

4-Level Output Signal Measurement

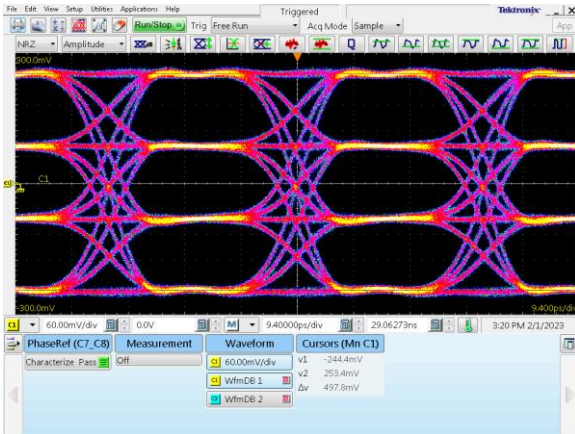

Out @ 32 GBaud

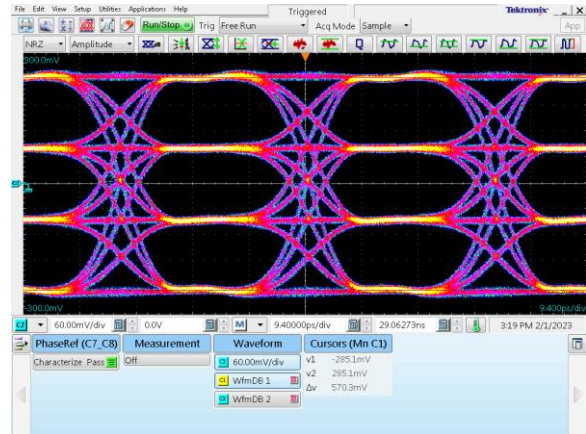

Out! @ 32 GBaud

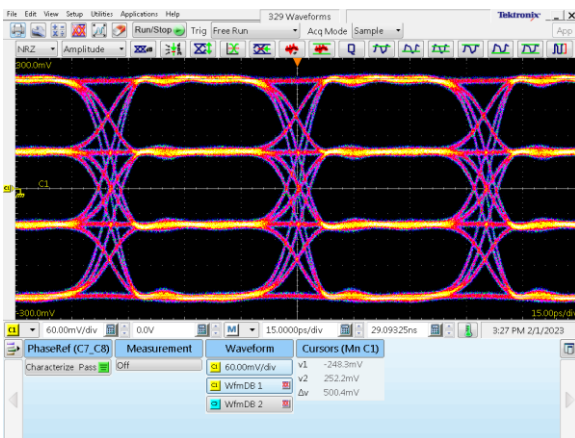

Out @ 20 GBaud

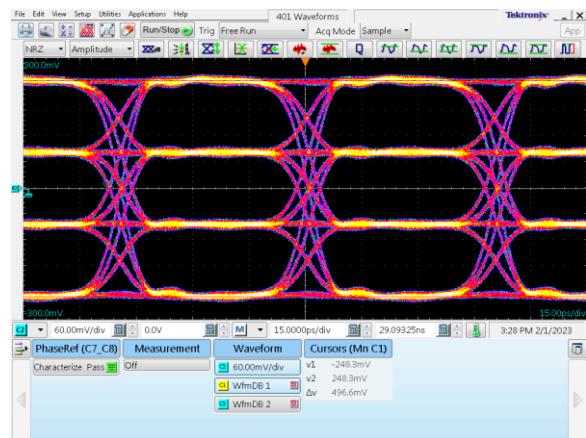

Out! @ 20 GBaud

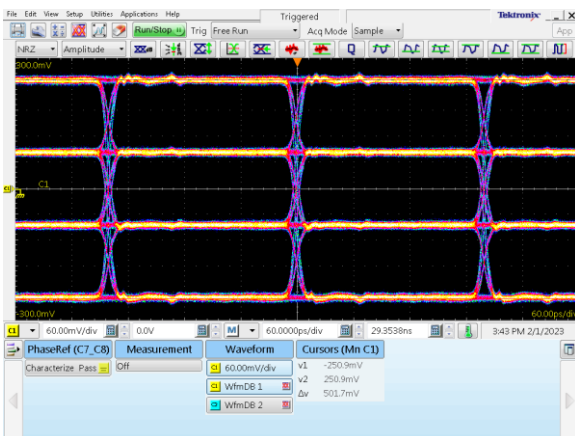

Out @ 5 GBaud

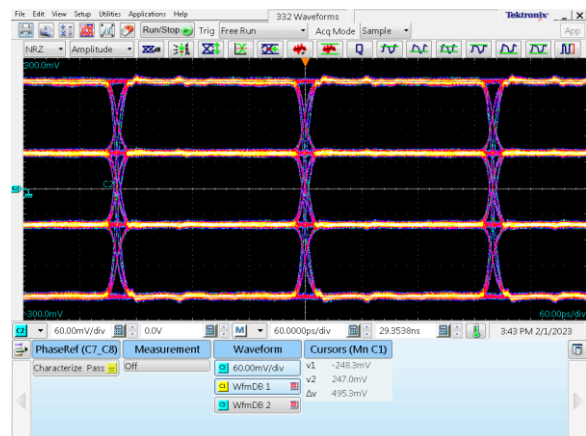

Out! @ 5 GBaud



8-Level Output Signal Measurement

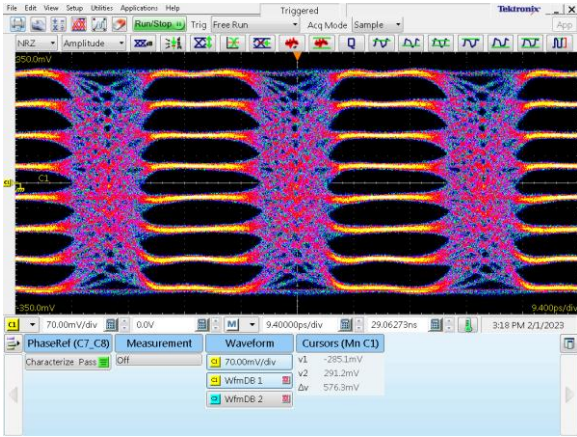

Out @ 32 GBaud

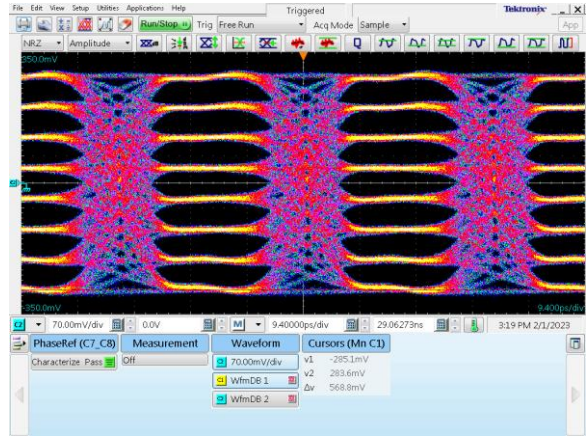

Out! @ 32 GBaud

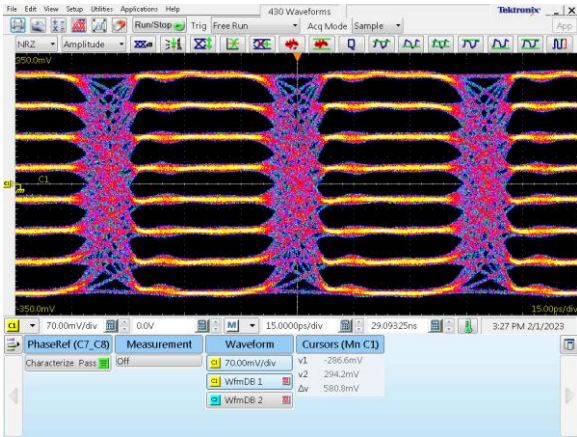

Out @ 20 GBaud

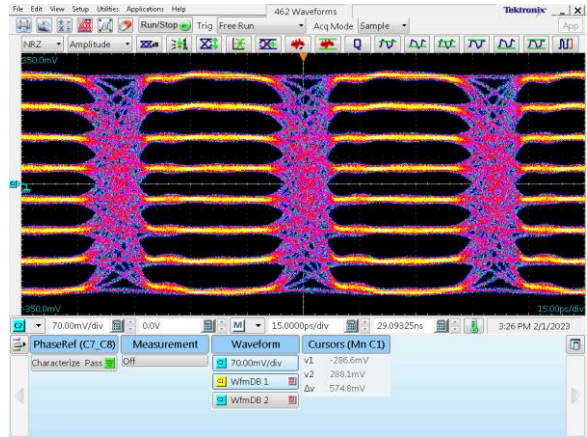

Out! @ 20 GBaud

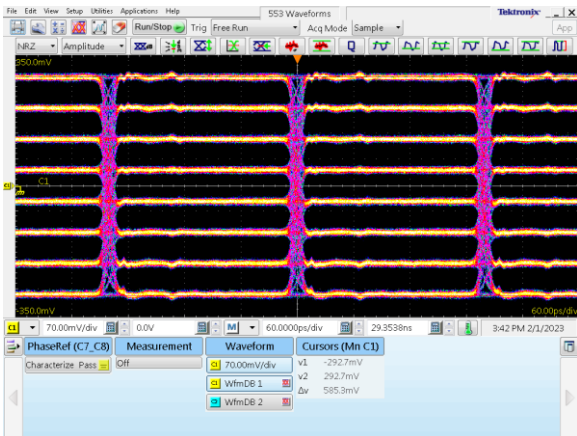

Out @ 5 GBaud

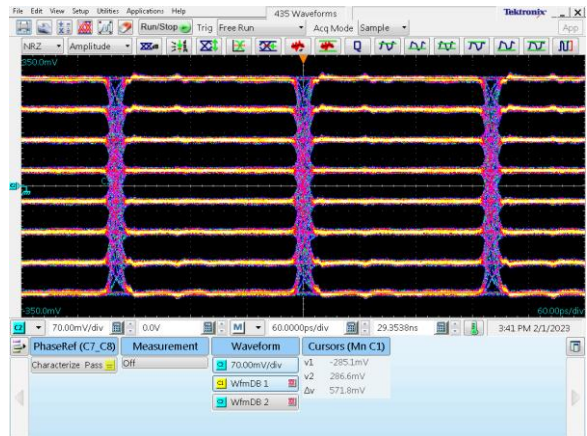

Out! @ 5 GBaud



16-Level Output Signal Measurement

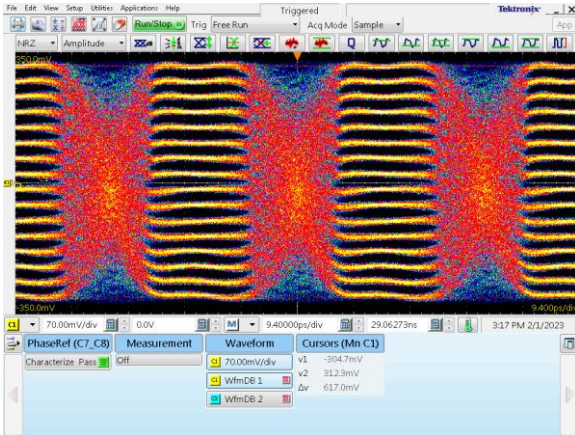

Out @ 32 GBaud

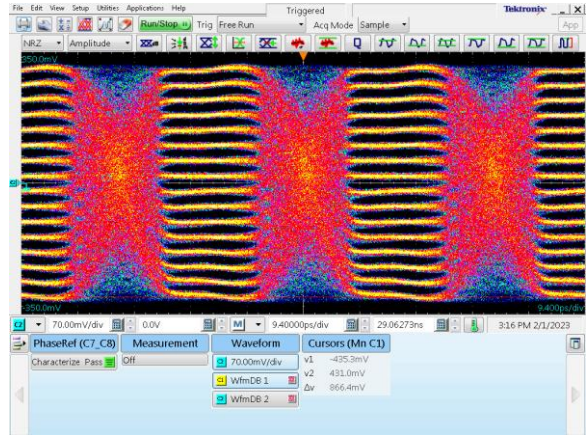

Out! @ 32 GBaud

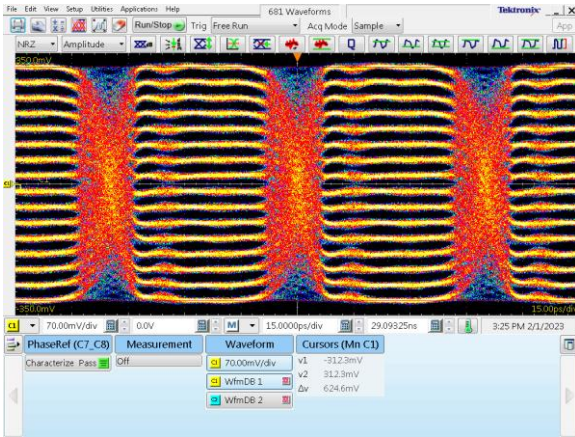

Out @ 20 GBaud

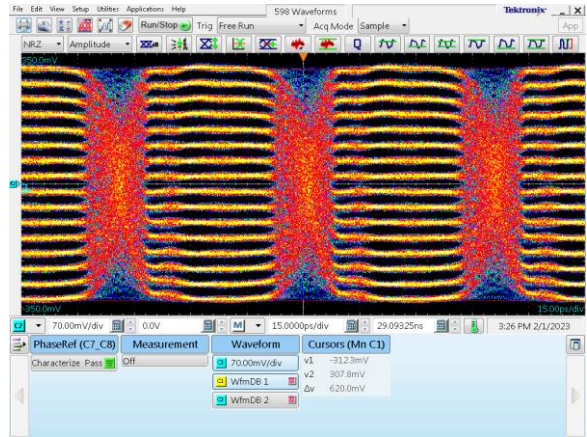

Out! @ 20 GBaud

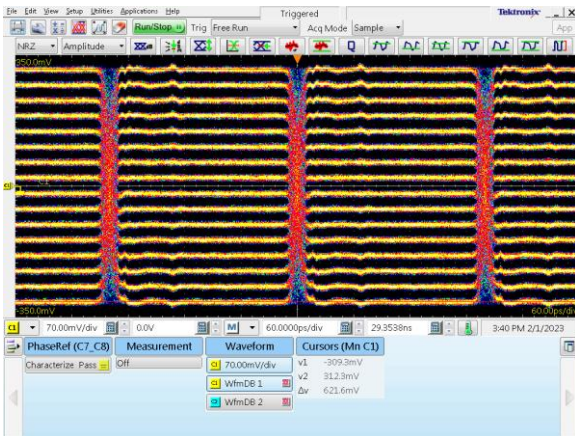

Out @ 5 GBaud

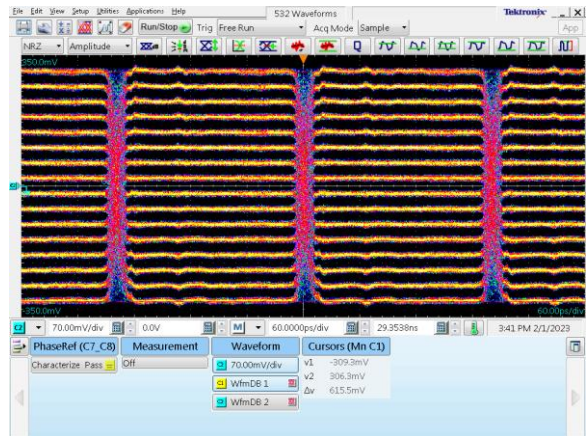

Out! @ 5 GBaud



Mechanical Drawing - Configuration 67

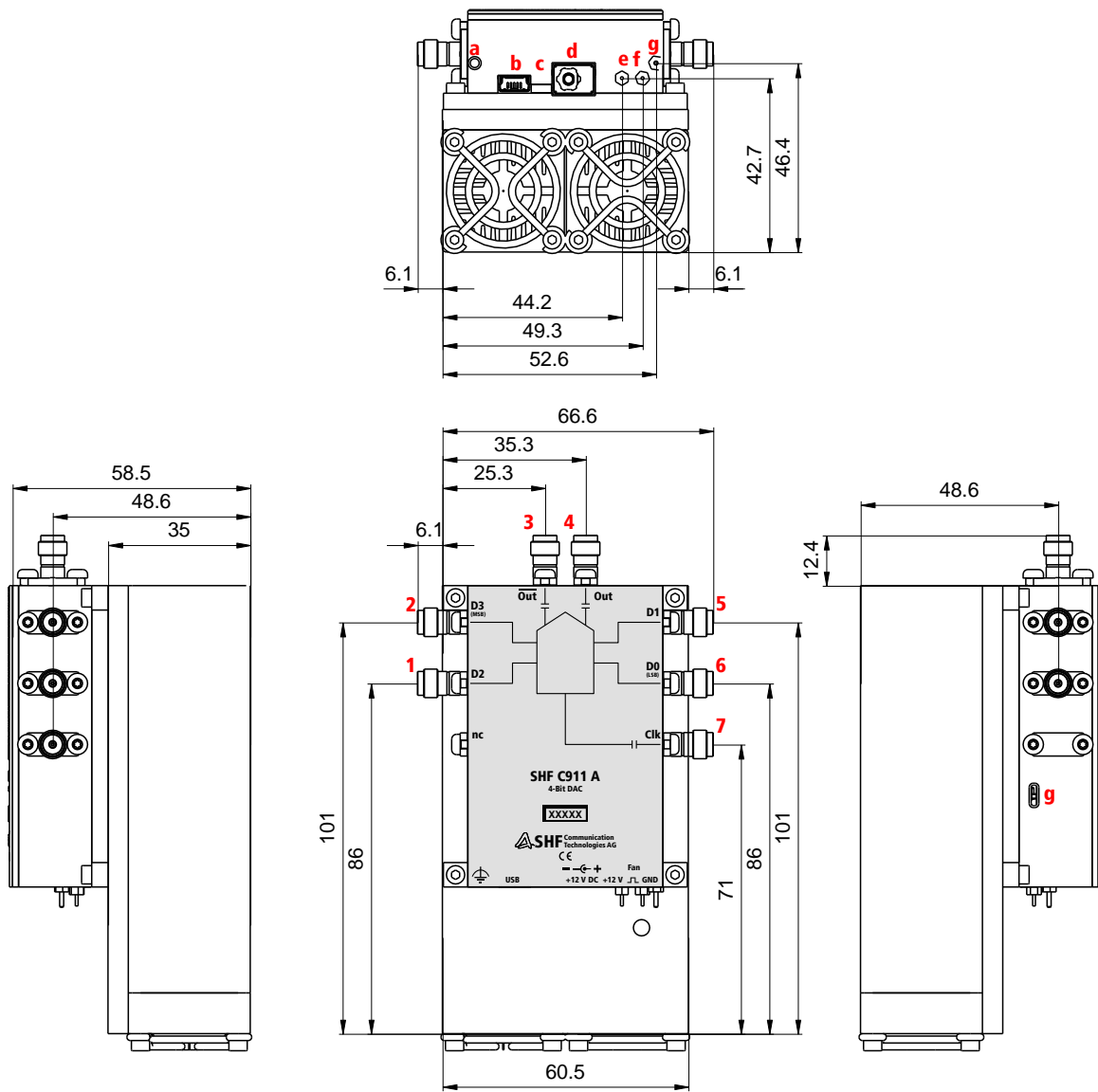

Pos	Port	Connector
1	D2	1.85mm (V) female
2	D3 (MSB)	1.85mm (V) female
3	Out	1.85mm (V) female
4	Out	1.85mm (V) female
5	D1	1.85mm (V) female
6	D0 (LSB)	1.85mm (V) female
7	Clk	1.85mm (V) female

Port	Connector
a	Functional earth (FE)
b	Mini-USB
c	Power-LED
d	Power
e	Fan+12V
f	Fan Tacho
g	GND
h	Service

all dimensions in mm

Mechanical Drawing (Module only) – Configuration 67

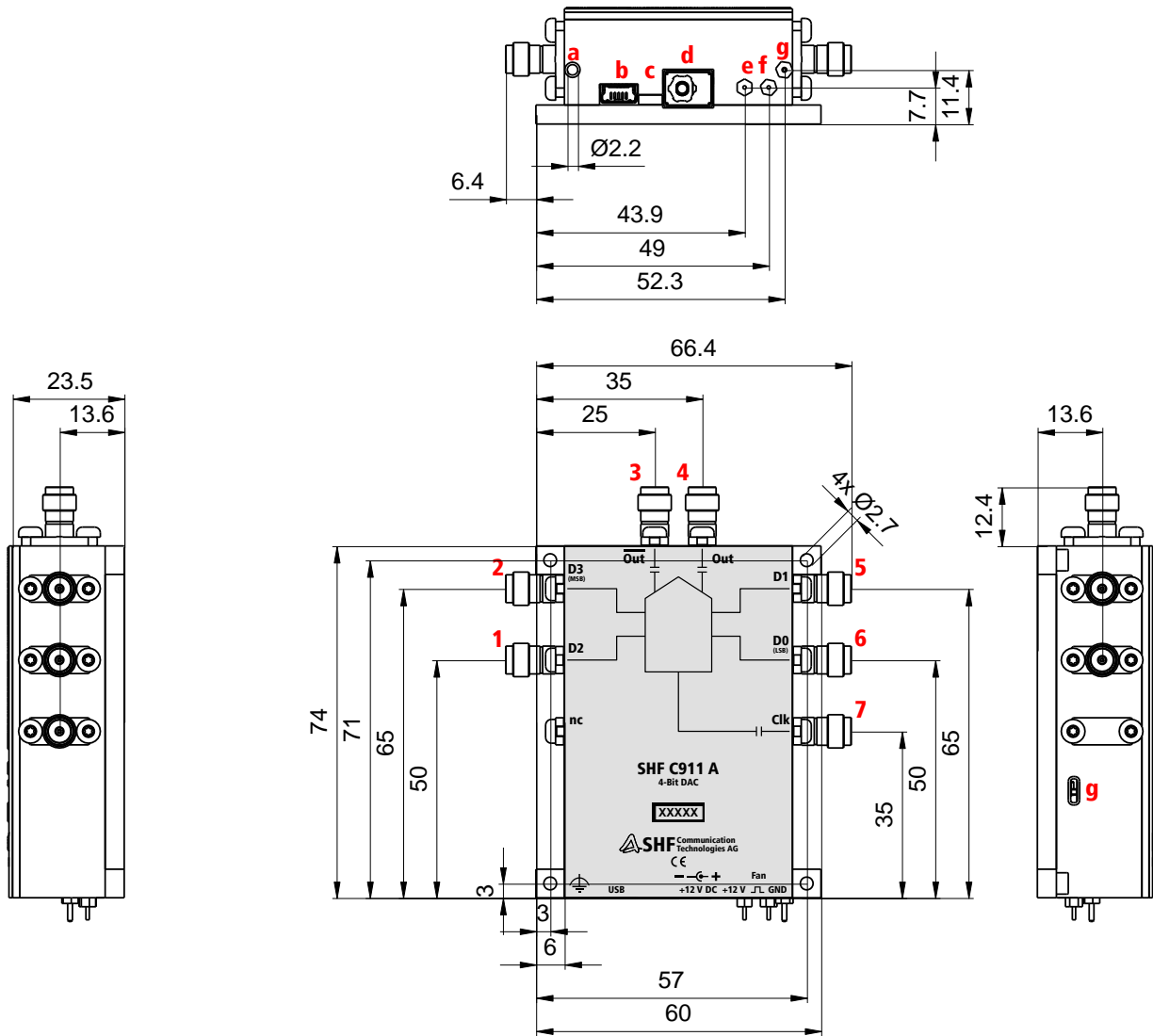

Pos	Port	Connector
1	D2	1.85mm (V) female
2	D3 (MSB)	1.85mm (V) female
3	Out	1.85mm (V) female
4	Out	1.85mm (V) female
5	D1	1.85mm (V) female
6	D0 (LSB)	1.85mm (V) female
7	Clk	1.85mm (V) female

Port	Connector
a	Functional earth (FE)
b	Mini-USB
c	Power-LED
d	Power
e	Fan+12V
f	Fan Tacho
g	GND
h	Service

all dimensions in mm

Mechanical Drawing – Configuration 32

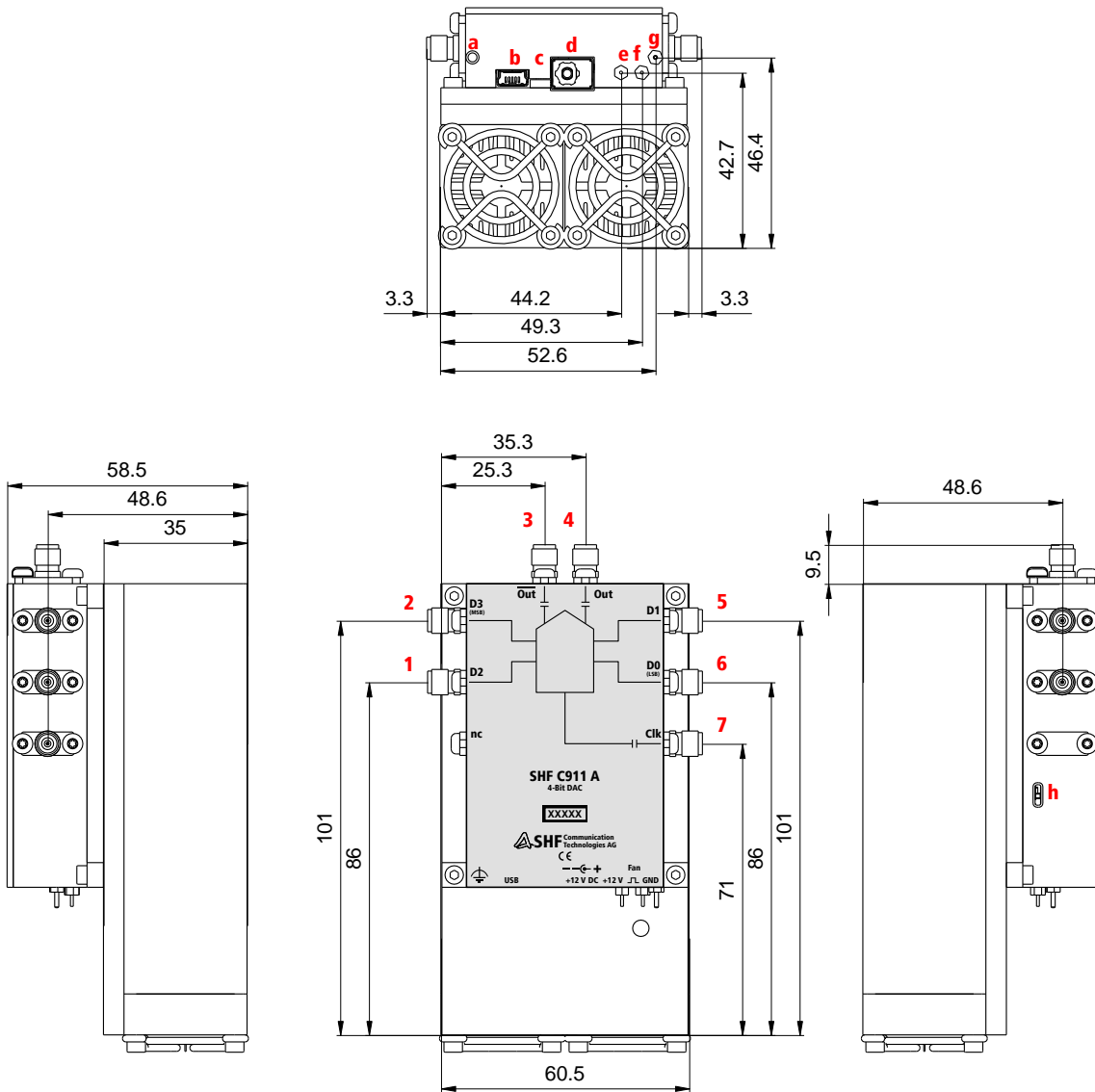

Pos	Port	Connector
1	D2	2.92mm (K) female
2	D3 (MSB)	2.92mm (K) female
3	Out	2.92mm (K) female
4	Out	2.92mm (K) female
5	D1	2.92mm (K) female
6	D0 (LSB)	2.92mm (K) female
7	Clk	2.92mm (K) female

Port	Connector
a	Functional earth (FE)
b	Mini-USB
c	Power-LED
d	Power
e	Fan+12V
f	Fan Tacho
g	GND
h	Service

all dimensions in mm

Mechanical Drawing (Module only) – Configuration 32

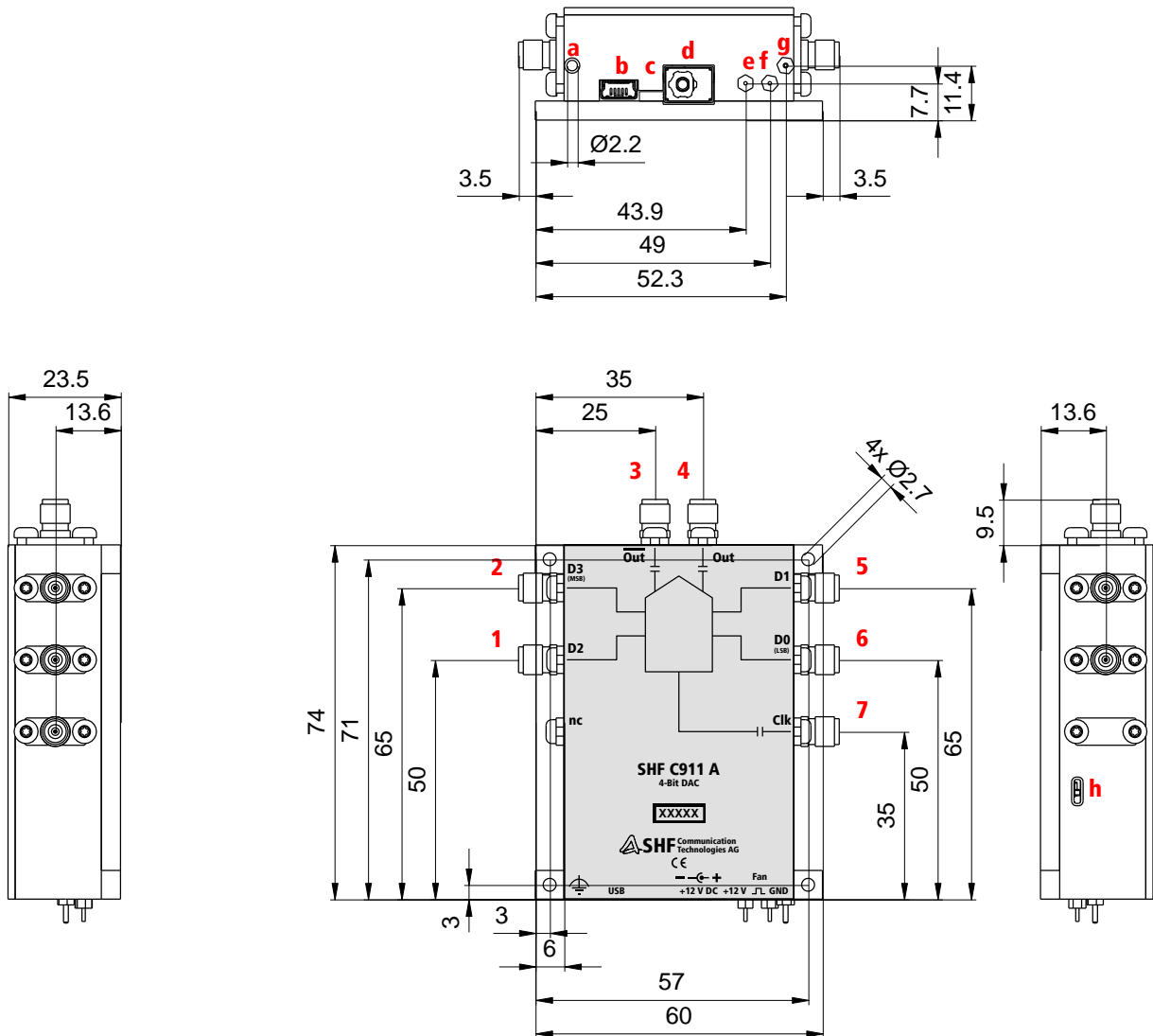

Pos	Port	Connector
1	D2	2.92mm (K) female
2	D3 (MSB)	2.92mm (K) female
3	Out	2.92mm (K) female
4	Out	2.92mm (K) female
5	D1	2.92mm (K) female
6	D0 (LSB)	2.92mm (K) female
7	Clk	2.92mm (K) female

Port	Connector
a	Functional earth (FE)
b	Mini-USB
c	Power-LED
d	Power
e	Fan+12V
f	Fan Tacho
g	GND
h	Service

all dimensions in mm



SHF Communication Technologies AG

Wilhelm-von-Siemens-Str. 23 D | 12277 Berlin | Germany

+49 30 772 051 0

sales@shf-communication.com

www.shf-communication.com