



## SHF Communication Technologies AG

Wilhelm-von-Siemens-Str. 23D • 12277 Berlin • Germany

Phone ++49 30 772 051-0 • Fax ++49 30 753 10 78

E-Mail: [sales@shf.de](mailto:sales@shf.de) • Web: <http://www.shf.de>

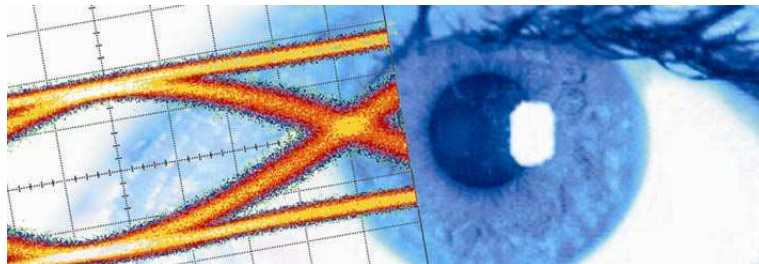

# Datasheet

## SHF 46121 C

### Optical Transmitter

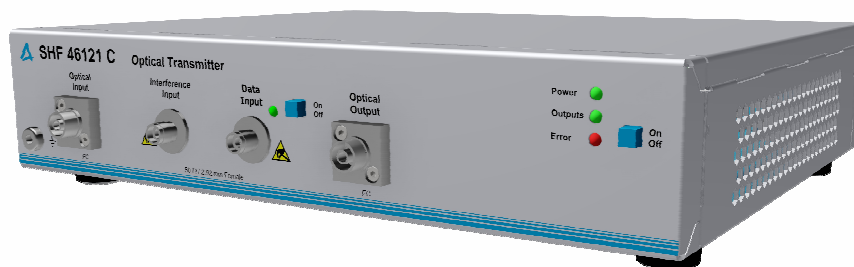



## Description

The SHF 46121 C is a stand-alone optical transmitter unit.

This optical transmitter converts electrical signals into optical signals at a data rate of at least 56 Gbps in ASK (amplitude shift keying) format.

PAM signal generation is possible up to ~ 40 GBaud when driving the data input with an electrical PAM signal.

The main element of the SHF 46121 C is a thermally stable Chirp-free Lithium Niobate Mach-Zehnder modulator which is driven by an individually optimized amplifier.

The temperature stable modulator and an automatic bias circuit ensure high stability of the output signal.

## Features

- $\geq 56$  Gbps optical data streams
- $< 9$  ps rise and fall time digital optical signals
- PAM 4 up to 40 GBaud
- Modulators' bias condition controlled automatically
- SONET/SDH compatible
- Stressed eye generation for optical compliance testing
- Interference input to set the Vertical Eye Closure Penalty (VECP)
- Selectable slope (positive slope / negative slope)
- 2 optical input power ranges available:
  - Standard power range: +6 ... +13 dBm
  - Low power option: 0 ... +10 dBm .

## Functional Block Diagram

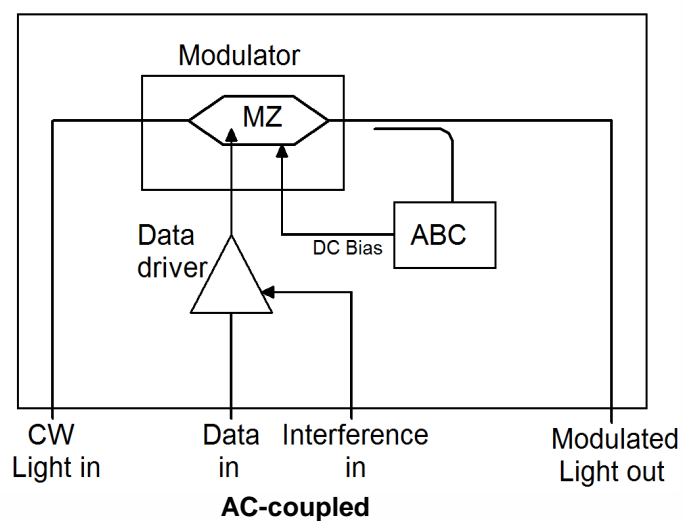



# Specifications – SHF 46121 C

Parameter	Unit	Min.	Typ.	Max.	Conditions
<b>Absolute Maximum Ratings</b>					
Optical Input Power	dBm			13	
Data Input Level	V <sub>pp</sub>	$V_{Data\_max} = 2 V - V_{Interference}$			The sum of data input and interference input shall not be larger than 2 V
Interference Input Level	V <sub>pp</sub>	$V_{Interference\_max} = 2 V - V_{Data}$			
DC Input Voltage (Data & Interference Input)	V			±9	
<b>Optical Parameters</b>					
Wavelength Range	nm	1550 +/- 50			
Insertion Loss	dB		7	8	connector to connector, modulator at quadrature point
DC Extinction Ratio	dB		>20		
Return Loss	dB		>20		
<b>Electrical and electro-optical parameters</b>					
EO Bandwidth of Modulator	GHz	20			-3dB electrical
EO Bandwidth of Transmitter	GHz	22			-3dB electrical
Optical input power	dBm	6		13	Standard ABC operating range Option low power
		0		10	
Min. Bit Rate	Gbps			2	
Max. Bit Rate		56	60		Criteria: Ext.Ratio & S/N @ PRBS 2 <sup>7</sup> -1 ... 2 <sup>31</sup> -1
Electrical Return Loss of Data Input	dB		10	7	1 MHz – 20 GHz
Data Input Level @ 32 Gbps	V <sub>pp</sub>		0.075		ExtRatio = 2 dB ExtRatio = 6 dB ExtRatio = 12 dB
			0.18		
			0.3		
Data Input Level @ 56 Gbps	V <sub>pp</sub>		0.075		ExtRatio = 2 dB ExtRatio = 6 dB ExtRatio = 11 dB
			0.18		
			0.35		
Dynamic Extinction Ratio range	dB	0		13	ABC operating range
	dB	9			Data input level : 0.3 V ... 0.5 V, ≤ 56 Gbps, PRBS
Dynamic Signal to Noise Ratio		14	16		≤ 50 Gbps,
		9	11		≤ 56 Gbps, PRBS
Output Rise and Fall Times	ps		8	9	ExtRatio >10 dB ExtRatio < 7 dB *Note
			13	14	

\* Note: rise time 20%...80% as displayed on 70 GHz oscilloscope, measured with drive level set to max. S/N



Electrical and electro-optical parameters					
Output Timing Jitter <RMS>	ps		1.0	1.2	Measured with SHF Pattern Generator, precision timebase DCA. De-embedded from 32 Gbps NRZ electrical data source
Crossing NRZ	%	45	50	55	* Note
Interference Input					
Low frequency limit	KHz		50	100	
High frequency limit	MHz	700	1000		
Input Voltage Interference Input	V <sub>pp</sub>			1	
Modulator Auto-bias control (ABC)					
Dither Signal Frequency	kHz		1		

\* Note: Input crossing = 50 %, signal measured @ ExtRatio 0...12 dB

## General Specifications

Parameter	Unit	Min.	Typ.	Max.	Conditions
Weight	kg		0.82		
Dimensions (W x H x D)	mm		221 x 51 x 177		w/o Frontpanel -Connectors
Power Consumption	W		10		+12V switching power supply is included
Operating Temperature	°C	10		35	
Electrical Data Input Connector					K (2.9mm) female
Interference Input Connector					K (2.9mm) female
Optical Connectors			FC/PC * Note		PMF in, key aligned to slow axis, PMF out

\* Note: Other connectors available on request





# Stressed Eye Generation

When driving the transmitter with an input signal below the compression level of ~ 300 mV<sub>pp</sub>, a stable but impaired eye diagram is generated.

Additional stress can be superposed by adding an external interference signal via a dedicated interference input.

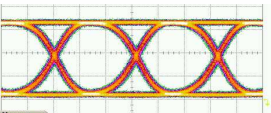
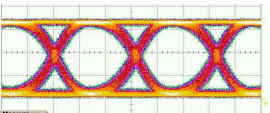
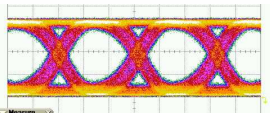
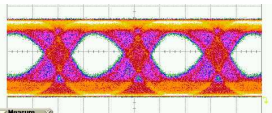
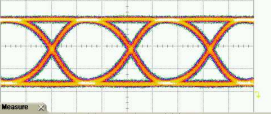
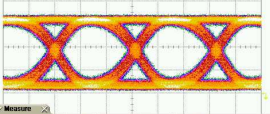
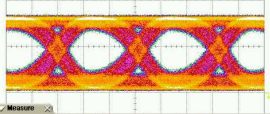
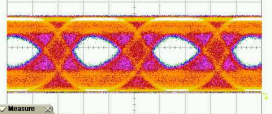
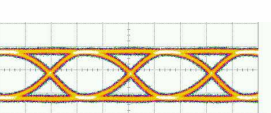
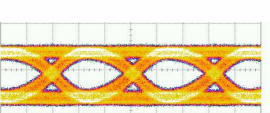
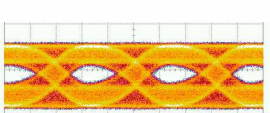
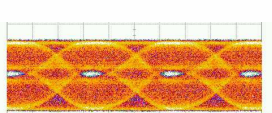
Measurements taken at 32 GBit/s, PRBS 2<sup>31</sup>-1. Data source: SHF 12104 BPG + SHF 613 DAC

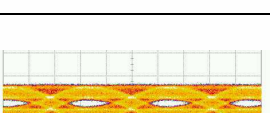
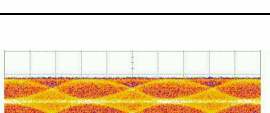
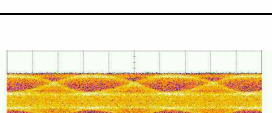
32 GBit/s	No interferer	200 mV <sub>pp</sub> interference	400 mV <sub>pp</sub> interference	600 mV <sub>pp</sub> interference
<b>Best signal quality</b> 270 mV drive amplitude	 S/N: 16.9 ExtRatio: 11.8 dB	 S/N: 16.9 ExtRatio: 11.8 dB	 S/N: 16.9 ExtRatio: 11.8 dB	 S/N: 16.9 ExtRatio: 11.8 dB
220 mV drive amplitude	 S/N: 21 ExtRatio: 9 dB	 S/N: 12 ExtRatio: 9.1 dB	 S/N: 7.1 ExtRatio: 8.5 dB	 S/N: 2 ExtRatio: 5 dB
150 mV drive amplitude	 S/N: 14.5 ExtRatio: 5.3 dB	 S/N: 5.9 ExtRatio: 5.2 dB	 S/N: 1.7 ExtRatio: 3.4 dB	 S/N: 1.7 ExtRatio: 3.4 dB
75 mV drive amplitude	 S/N: 11.2 ExtRatio: 2.4 dB	 S/N: 11.2 ExtRatio: 2.4 dB	 S/N: 11.2 ExtRatio: 2.4 dB	 S/N: 11.2 ExtRatio: 2.4 dB



# Typical ASK Results

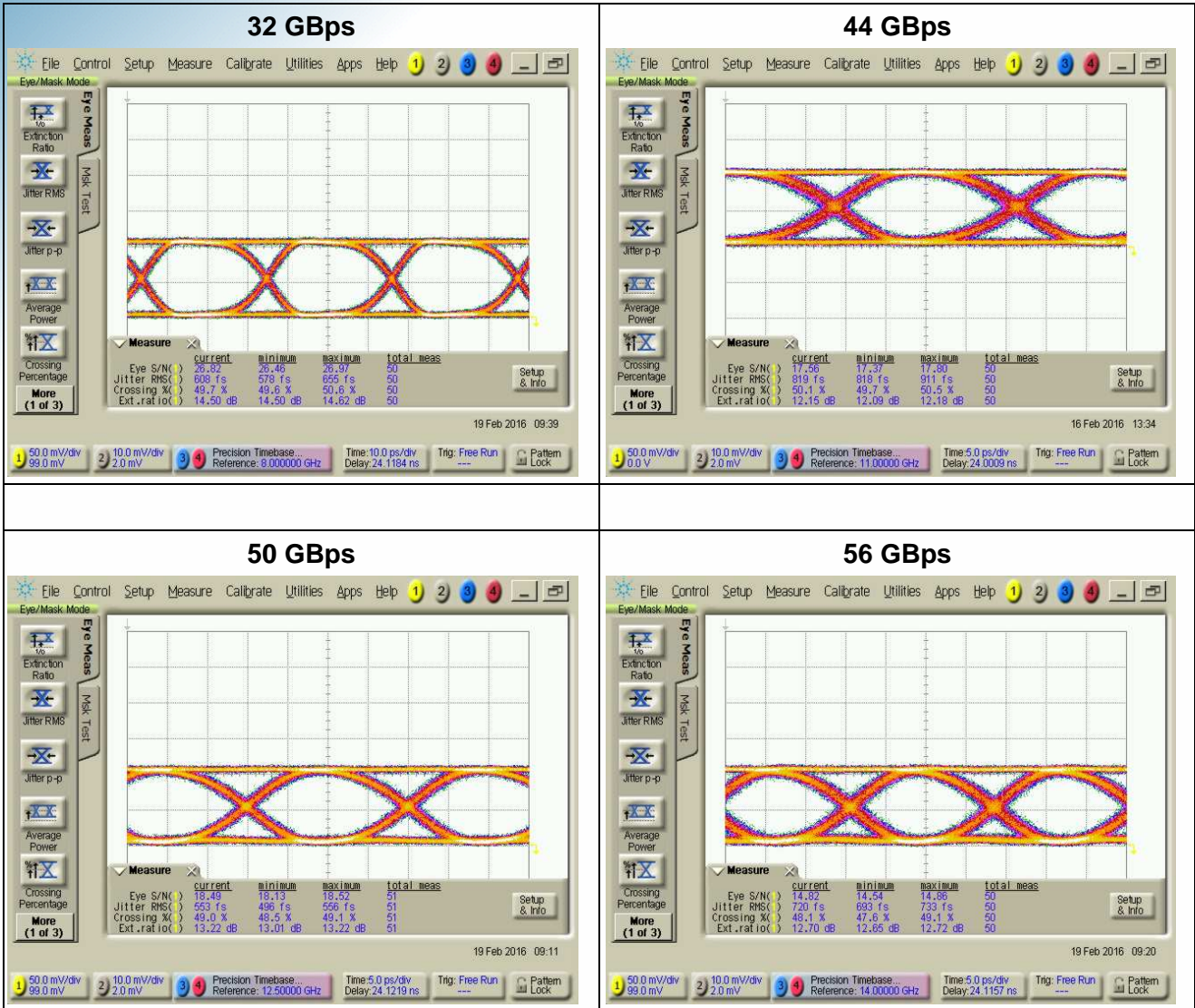

# Typical PAM4 Results

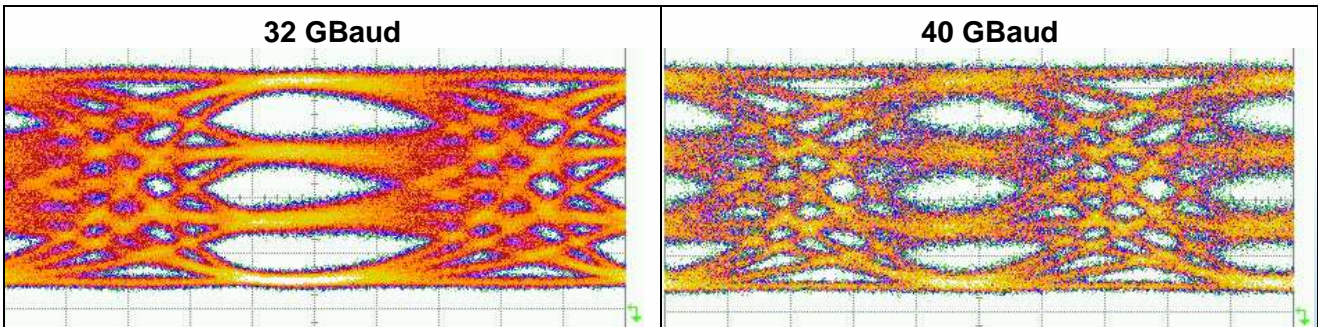



# Outline Drawing

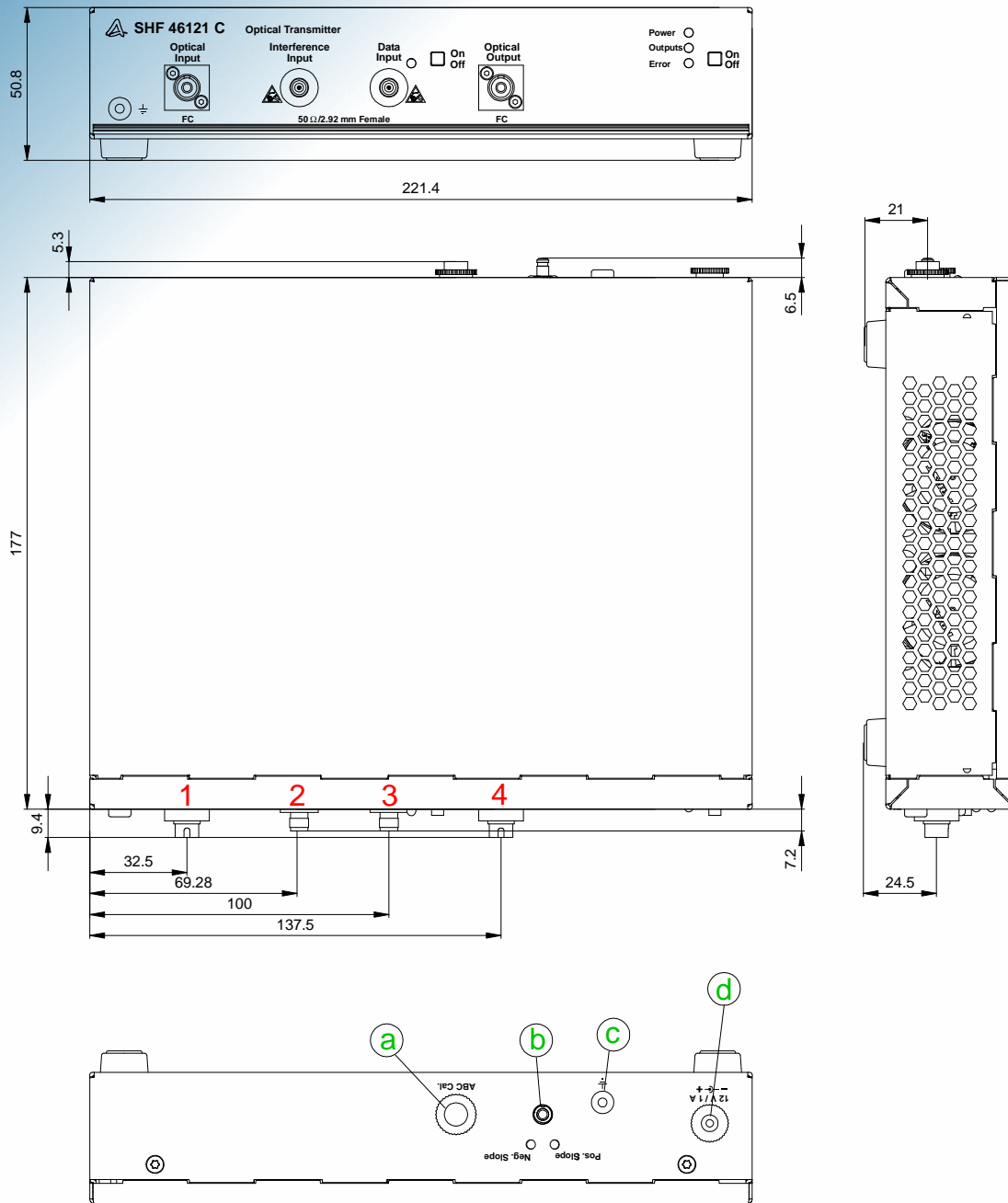

Pos.	Designation	Connector
1	Optical Input	FC
2	Interference Input	2.92mm (K) Female
3	Data Input	2.92mm (K) Female
4	Optical Output	FC

Pos.	Designation
a	ABC Calibration
b	Positive Negative Slope switch
c	GND
d	Power Supply

All dimensions are specified in millimeters (mm).