



SHF Communication Technologies AG

Wilhelm-von-Siemens-Str. 23D • 12277 Berlin • Germany

Phone ++49 30 772 051-0 • Fax ++49 30 753 10 78

E-Mail: sales@shf.de • Web: <http://www.shf.de>

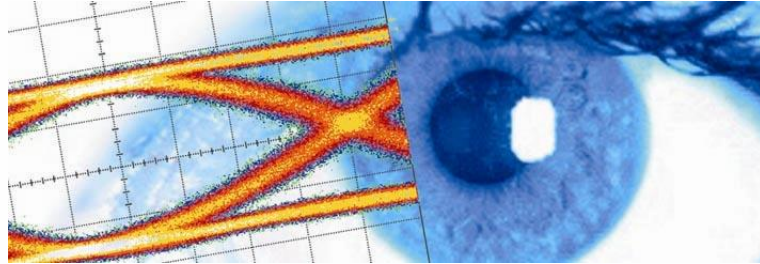

Datasheet

SHF 46120 B

Optical Transmitter

1310 nm + 1550 nm





Description

The SHF 46120 B is a stand alone optical transmitter unit.

The transmitter works in C+L band and O band.

This optical transmitter converts electrical signals into optical signals at a data rate of up to 50 Gbps in ASK (amplitude shift keying) format.

PAM signal generation is possible up to ~ 32 GBaud when driving the data input with an electrical PAM signal.

The main element of the SHF 46120 B is a thermally stable Chirp-free Lithium Niobate Mach-Zehnder modulator which is driven by an individually optimized amplifier.

The temperature stable modulator and an automatic bias circuit ensure high stability of the output signal.

Features

- Dualband 1310 nm and 1550 nm
- ≥ 50 Gbps optical data streams
- ≤ 10 ps rise and fall time compressed digital optical signals
- PAM 4 up to 32 GBaud
- Modulators' bias condition controlled automatically
- SONET/SDH compatible
- Stressed eye generation for optical compliance testing
- Interference input to set the Vertical Eye Closure Penalty (VECP)
- Selectable slope (positive slope / negative slope)

Functional block diagram

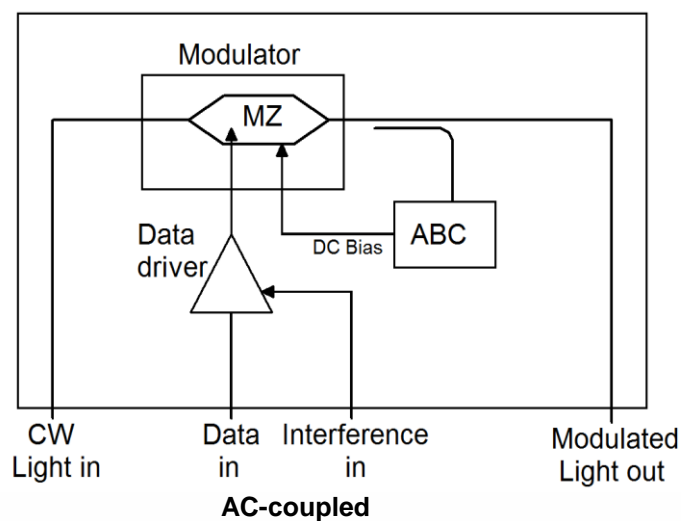



Specifications – SHF 46120 B

Parameter	Unit	Min.	Typ.	Max.	Conditions
Absolute Maximum Ratings					
Optical Input Power	dBm			17	
Data Input Level	V _{pp}	$V_{Data_max} = 2 V - V_{Interference}$			The sum of data input and interference input shall not be larger than 2 V
Interference Input Level	V _{pp}	$V_{Interference_max} = 2 V - V_{Data}$			
DC Input Voltage (Data & Interference Input)	V			±9	
Optical Parameters					
Wavelength Range	nm	1260 - 1360, 1530 - 1625 O band, C+L-band			
Insertion Loss	dB		8	9	connector to connector, modulator at quadrature point
DC Extinction Ratio	dB		20		
Return Loss	dB		tbd		
Electrical and electro-optical parameters (measured at 1550 nm)					
EO Bandwidth of Modulator	GHz	18			-3dB electrical
EO Bandwidth of Transmitter	GHz	20			-3dB electrical
Optical input power	dBm	6		15	ABC operating range
Min. Bit Rate	Gbps			2	
Max. Bit Rate	Gbps	44	50		Criteria: Ext.Ratio & S/N @ PRBS 2 ⁷ -1 ... 2 ³¹ -1
Electrical Return Loss of Data Input	dB		-10	-7	1 MHz – 20 GHz
Data Input Level	V _{pp}		0.075 0.2 0.4		ExtRatio = 2 dB ExtRatio = 6 dB ExtRatio = 12 dB
Dynamic Extinction Ratio range	dB	0		13	ABC operating range
Dynamic Extinction Ratio	dB	10 9	11		Data input level : 0.4 V ... 0.5 V, ≤ 44 Gbps ... ≤ 50 Gbps, PRBS
Dynamic Signal to Noise Ratio	dB	16 10	18		Data input level : 0.4 V ... 0.5 V, ≤ 44 Gbps ... ≤ 50 Gbps, PRBS
Output Rise and Fall Times	ps		9 13	10 14	ExtRatio > 10 dB ExtRatio < 7 dB *Note
Output Timing Jitter <RMS>	ps		1.0	1.2	Measured with SHF Pattern Generator, precision timebase DCA. De-embedded from 32 Gbps NRZ electrical data source

* Note: rise time 20%...80% as displayed on 70 GHz oscilloscope using a 70 GHz detector



Electrical and electro-optical parameters					
Crossing NRZ	%	45	50	55	* Note
Interference Input					
Low frequency limit	KHz		50	100	
High frequency limit	MHz	700	1000		
Input Voltage Interference Input	V _{pp}			1	
Auto-bias control (ABC)					
Dither Signal Frequency	kHz		1		

* Note: Input crossing = 50 %, signal measured @ ExtRatio 0...13 dB

General specifications

Parameter	Unit	Min.	Typ.	Max.	Conditions
Weight	kg		0.82		
Dimensions (W x H x D)	mm		115 x 64 x 174		w/o Frontpanel - Connectors
Power Consumption	W		10		
Operating Temperature	°C	10		35	
Electrical Data Input Connector					K (2.9mm) female
Interference Input Connector					K (2.9mm) female
Optical Connectors			FC/PC * Note		PMF in, key aligned to slow axis, SMF out

* Note: Other connectors available on request



Stressed eye generation

When driving the transmitter with an input signal below the compression level of ~ 500 mV_{pp}, a stable but impaired eye diagram is generated.

Additional stress can be superposed by adding an external interference signal via a dedicated interference input.

Measurements taken at 32 GBit/s, PRBS 2³¹-1. Data source: SHF 12104 BPG + SHF 613 DAC

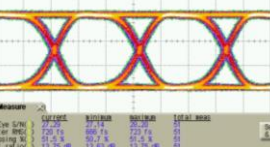
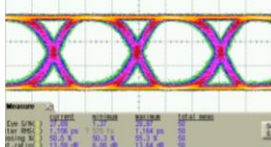
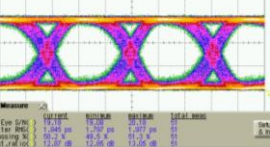
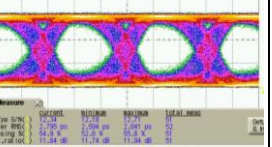
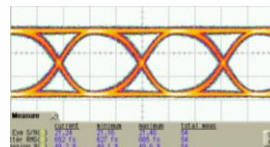
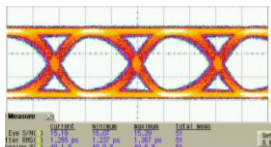
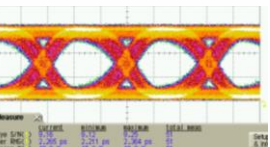
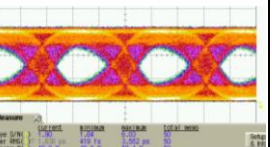
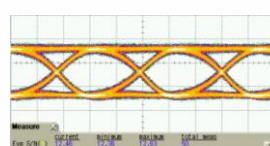
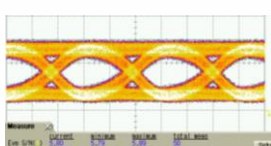
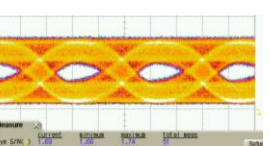
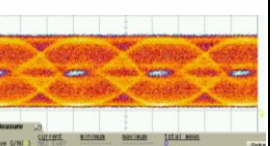
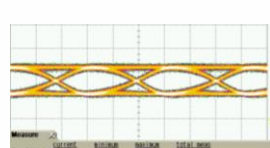
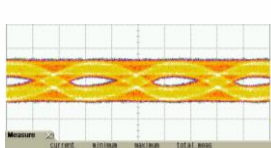
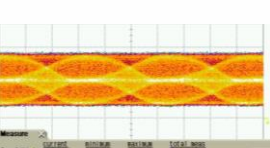
	No interferer	300 mV _{pp} (10 MHz) Interference	600 mV _{pp} (10 MHz) interference	900 mV _{pp} (10 MHz) interference
470 mV _{pp} data drive amplitude	 <p>S/N: 27 ExtRatio: 14 dB</p>	 <p>S/N: 27 ExtRatio: 14 dB</p>	 <p>S/N: 19 ExtRatio: 13 dB</p>	 <p>S/N: 12 ExtRatio: 12 dB</p>
330 mV _{pp} data drive amplitude	 <p>S/N: 21 ExtRatio: 10 dB</p>	 <p>S/N: 15 ExtRatio: 10 dB</p>	 <p>S/N: 9 ExtRatio: 10 dB</p>	 <p>S/N: 2 ExtRatio: 5.5 dB</p>
200 mV _{pp} data drive amplitude	 <p>S/N: 12 ExtRatio: 6 dB</p>	 <p>S/N: 6 ExtRatio: 6 dB</p>	 <p>S/N: 2 ExtRatio: 3.6 dB</p>	 <p>S/N: -- ExtRatio: -- dB</p>
100 mV _{pp} data drive amplitude	 <p>S/N: 9 ExtRatio: 3 dB</p>	 <p>S/N: -- ExtRatio: -- dB</p>	 <p>S/N: -- ExtRatio: -- dB</p>	



Typical transmitter output signals

Data source: SHF 12104 BPG + SHF 613 DAC

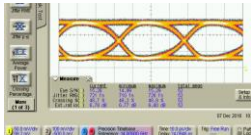
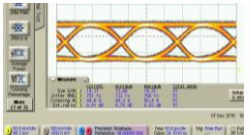
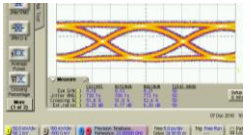
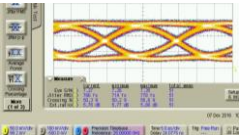
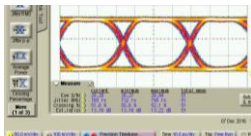
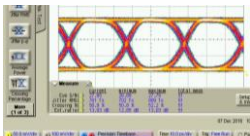
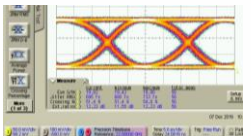
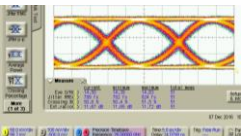
Binary (NRZ)	28 GBit/s	32 GBit/s	44 GBit/s	50 GBit/s
Linear operation 220 mV _{pp} data drive amplitude	 S/N: 15 Jitter: 721 fs Crossing: 49 % ExtRatio: 6.8 dB	 S/N: 14 Jitter: 751 fs Crossing: 50 % ExtRatio: 6.8 dB	 S/N: 9.2 Jitter: 738 fs Crossing: 52 % ExtRatio: 6.2 dB	 S/N: 7.3 Jitter: 786 fs Crossing: 50 % ExtRatio: 5.8 dB
compressed operation 460 mV _{pp} data drive amplitude	 S/N: 28 Jitter: 765 fs Crossing: 52 % ExtRatio: 13 dB	 S/N: 28 Jitter: 761 fs Crossing: 51 % ExtRatio: 13 dB	 S/N: 20 Jitter: 695 fs Crossing: 51 % ExtRatio: 12 dB	 S/N: 15 Jitter: 789 fs Crossing: 51 % ExtRatio: 12 dB

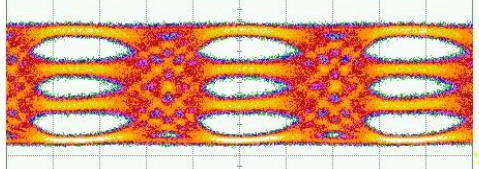
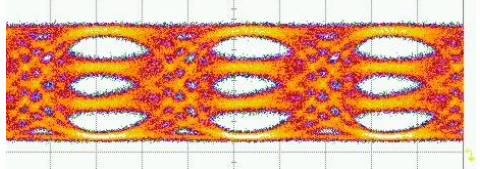
	28 GBaud	32 GBaud
PAM4 300 mV _{pp} data drive amplitude		



Outline Drawing

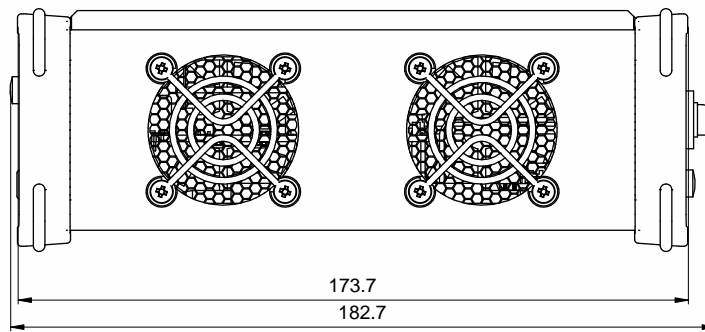
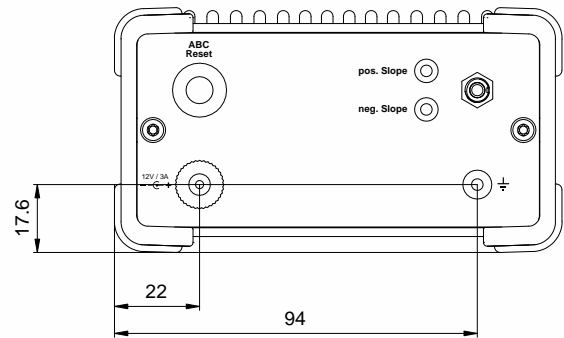
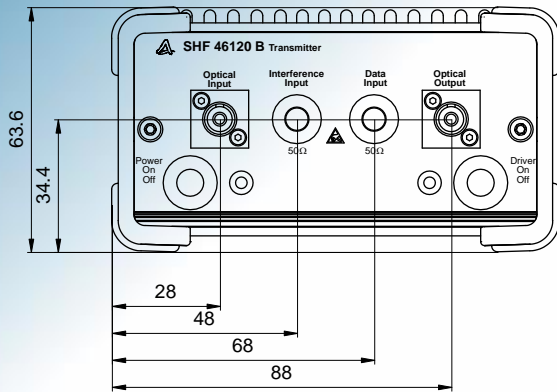

All dimensions are specified in millimeters (mm).